



INSTALLATION, OPERATION &
MAINTENANCE MANUAL

BluE-H5/H3 ENERGY STORAGE SYSTEM

Copyright Statement

This manual is under the copyright of Shenzhen Kstar Science and Technology Co., Ltd, with all rights reserved. Please keep the manual properly and operate in strict accordance with all safety and operating instructions in this manual. Please do not operate the system before reading through the manual. Contact the nearest hazardous waste disposal station when the products or components are discarded.

CONTENTS

01	Introduction	01
1.1	System Introduction	01
1.2	Operation Modes	03
1.3	Safety Introduction	04
1.4	Battery Safety Datasheet	06
1.5	General Precautions	07
1.6	Parts List	08
1.7	System Appearance	11
1.8	Liability Limitation	13
02	Installation	14
2.1	Installation Site and Environment	14
2.2	Installation	16
2.3	External CT Connection	27
2.4	DRED Port Connections(optional)	27
2.5	Single Line Diagram	28
03	System Operation	30
3.1	Switch on	30
3.2	Switch off	31
3.3	Emergency Procedure	31
04	EMS Introduction and Set up	32
4.1	Function Description	32
4.2	Display and Setting	34
4.3	Setting	38
4.4	Inquiry	62
4.5	Statistics	64
4.6	Restart	65
05	Battery Storage And Recharging	66
5.1	Battery Storage Requirements	66
5.2	Storage Expirations	64
5.3	Inspection Before Battery Recharging	67
06	Stick Logger Quick Guide	68
6.1	Download APP	68
6.2	Stick Logger Installation	68
6.3	Logger Status	69
6.4	Abnormal State Processing	69
6.5	Usage Methods and Notices for Reset Button	71
07	SOLARMAN Smart APP	72
7.1	Registration	72
7.2	Create a Plant	72
7.3	Add a Logger	72
7.4	Network Configuration	73
08	Alarm Code and Error Code	75
8.1	Alarm Code	75
8.2	Error Code	76
09	Fault Diagnosis and Solutions	77
10	Product Specifications	80
11	Routine Maintenance	85
12	Quality Assurance	87
13	Contact Informaiton	88

01 Introduction

1.1 System Introduction

BluE-H5 (incl. BluE-PACK10.2 and BluE-S 5000D-M1)/BluE-H3 (incl. BluE-PACK5.1 and BluE-S 3680D-M1) can be applied in DC-coupled systems (mostly new installation), AC-coupled systems (mostly retrofit) and Hybrid-coupled systems (mostly retrofit, and PV capacity-increase), as the following schemes show:

Solution	Configuration	
	Inverter	ESS
BluE H3-5	BluE-S 3680D-M1	BluE-PACK5.1
BluE H3-10	BluE-S 3680D-M1	BluE-PACK10.2
BluE H5-10	BluE-S 5000D-M1	BluE-PACK10.2
BluE H5-20	BluE-S 5000D-M1	BluE-PACK20.4

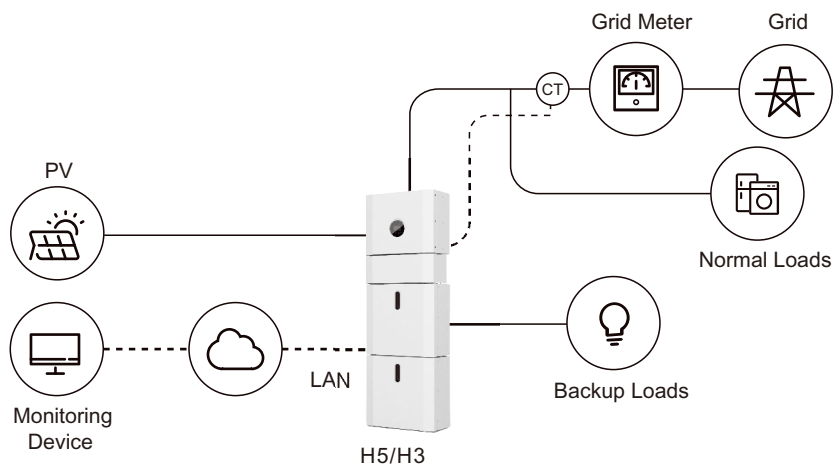

Figure1 DC-coupled Storage System – Scheme

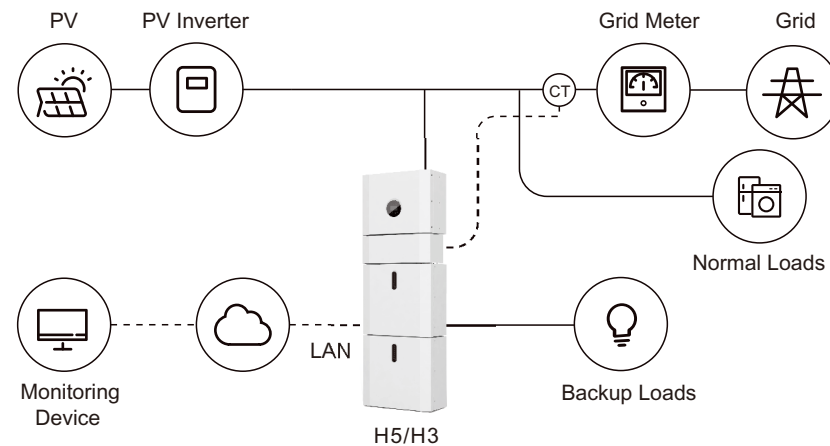

Figure 2 AC-coupled Storage System–Scheme

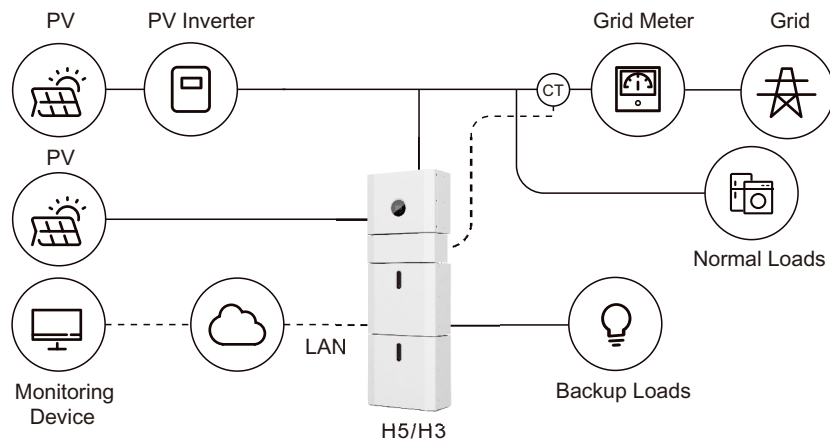
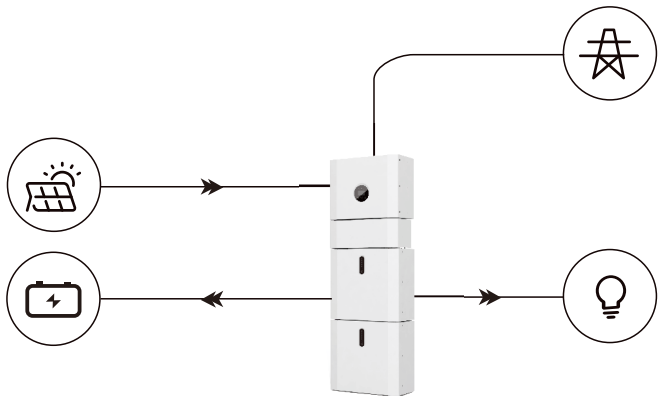

Figure 3 Hybrid-coupled Storage System–Scheme

1.2 Operation Modes:

There are three basic modes that end users can choose via inverter screen/APP.

• **SELF CONSUME:** The energy generated by the solar panels will be used in the following order: Feed the home loads; Charge the battery and then, feed into the grid. When the sun is off, the load will be supported by battery to enhance self consumption. If the power supply from the batteries is not sufficient, the grid will support the load demand.



• **BAT PRIORITY:** Under this mode, the battery is only used as a backup power supply when the grid fails and as long as the grid works, the batteries won't be used to power the loads. The battery will get charged with the power generated by the PV system or from the grid.

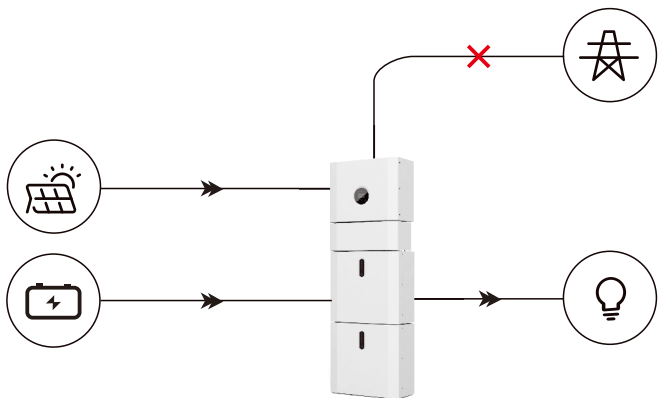

• **PEAK SHIFT:** This mode is designed for time-use mode customer. The customer is able to set up the charging/discharging time & power via inverter screen or APP.

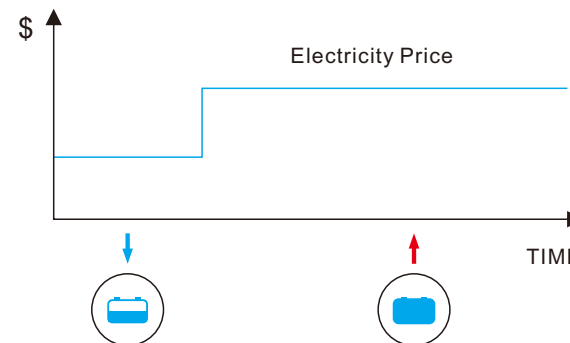

1.3 Safety Introduction

1.3.1 Manual Keeping

This manual contains important information about operating the system. Before operating, please read it very carefully. The system should be operated in strict accordance with the instructions in the manual, otherwise it can cause damages or loss to equipment, personnel and property. This manual should be kept carefully for maintenance.

1.3.2 Operator Requirements

The operators should get a professional qualification, or be trained. The operators should be familiar with the whole storage system, including compositions and working principles of the system. The operators should be familiar with the Product Instruction. While maintaining, the maintainer is not allowed to operate any equipment until all the equipment has been turned off and fully discharged.

1.3.3 Protection of Warning Sign

The warning signs contain important information for the system to operate safely, and it is strictly prohibited to tear or damage them. Ensure that the warning signs are always well-functioned and correctly placed. The signs must be replaced immediately when damaged.



This sign indicates a hazardous situation which, if not avoided, could result in death or serious injury!

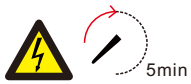

The H5/H3 must not be touched or put into service until 5 minutes after it has been switched off or disconnected to prevent an electric shock or injury.



This sign shows danger of hot surface!



Refer to the operating instructions.

1.3.4. Setting of Warning Sign for Safety

During instruction, maintenance and repair, follow the instructions below to prevent non-specialist personnel from causing misuse or accident:

- Obvious signs should be placed at front switch and rear switch to prevent accidents caused by false switching.
- Warning signs should be set near operating areas.
- The system must be reinstalled after maintenance or operation.

1.3.5 Measuring Equipment

To ensure the electrical parameters to match requirements, related measuring equipment are required when the system is being connected or tested. Ensure that the connection and use matched specification to prevent electric arcs or shocks.

1.3.6 Moisture Protection

It is very likely that moisture may cause damages to the system. Repair or maintaining activities in wet weather should be avoided or limited.

1.3.7 Operation After Power Failure

The battery system is part of the energy storage system which stores life-threatening high voltage even when the DC side is switched off. Touching the battery outlets is strictly prohibited. The inverter can keep a life-threatening voltage even after disconnecting it from the DC and / or AC side. Therefore, for safety reasons, it must be tested with a properly calibrated voltage tester before an installer works on the equipment.

1.4 Battery Safety Datasheet

1.4.1 Hazard Information

Classification of the hazardous chemical

Exempt from classification according to Australian WHS regulations.

Other hazards

This product is a Lithium Iron Phosphate Battery with certified compliance under the UN Recommendations on Transport of Dangerous Goods, Manual of Tests and Criteria, Part III, subsection 38.3. For the battery cell, chemical materials are stored in a hermetically sealed metal case, designed to withstand temperatures and pressures encountered during normal use. As a result, during normal use, there is no physical danger of ignition or explosion and chemical danger of hazardous materials' leakage. However, if the product is exposed to a fire, added mechanical shocks, decomposed, added electric stress by misuse, the gas release vent will be operated. The battery cell case will be breached at the extreme. Hazardous materials may be released. Moreover, if heated strongly by the surrounding fire, acrid or harmful fume may be emitted.

1.4.2 Safety Datasheet

For detailed information please refer to the provided battery safety datasheet.

1.5 General Precautions

⚠ DANGER

Danger to life due to high voltages of the PV array, battery and electric shock. When exposed to sunlight, the PV array generates dangerous DC voltage which will be present in the DC conductors and the live components of the inverter. Touching the DC conductors or the live components can lead to lethal electric shocks. If you disconnect the DC connectors from the system under load, an electric arc may occur leading to electric shock and burns.

- ◆ Do not touch uninsulated cable ends.
- ◆ Do not touch the DC conductors.
- ◆ Do not open the inverter and battery.
- ◆ Do not wipe the system with damp cloth.
- ◆ Have the system installed and commissioned by qualified personnel with the appropriate skills only.
- ◆ Prior to performing any work on the inverter or the battery pack, disconnect the inverter from all voltage sources as described in this document.

⚠ WARNING

Risk of chemical burns from electrolyte or toxic gases. During standard operation, no electrolyte shall leak from the battery pack and no toxic gases shall form. Despite careful construction, if the Battery Pack is damaged or a fault occurs, it is possible that electrolyte may be leaked or toxic gases formed.

- ◆ Do not install the system in any environment of temperature below -10°C or over 50°C and in which humidity is over 90%.
- ◆ Do not touch the system with wet hands.
- ◆ Do not put any heavy objects on top of the system.
- ◆ Do not damage the system with sharp objects.
- ◆ Do not install or operate the system in potentially explosive atmospheres or areas of high humidity.
- ◆ Do not mount the inverter and the battery pack in areas containing highly flammable materials or gases.
- ◆ If moisture has penetrated the system (e.g. due to a damaged enclosure), do not install or operate the system.
- ◆ Do not move the system when it is already connected with battery modules. Secure the system to prevent tipping with restraining straps in your vehicle.
- ◆ The transportation of H5/H3 must be made by the manufacturer or an instructed personnel. These instructions shall be recorded and repeated.

- ◆ A certified ABC fire extinguisher with minimum capacity of 2kg must be carried along when transporting.
- ◆ It is totally prohibited to smoke in the vehicle as well as close to the vehicle when loading and unloading.
- ◆ For the exchange of a battery module, please request for new hazardous goods packaging if needed, pack it and let it be picked up by the suppliers.
- ◆ In case of contact with electrolyte, rinse the affected areas immediately with water and consult a doctor without delay.

⚠ CAUTION:









Risk of injury through lifting or dropping the system. The inverter and battery are heavy. There is risk of injury if the inverter or battery is lifted incorrectly or dropped during transport or when attaching to or removing from the wall.



- ◆ Lifting and transporting the inverter and battery must be carried out by more than 2 people.





1.6 Parts List



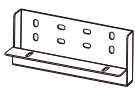

Check the following parts list to ensure it is complete.

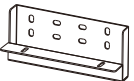

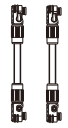
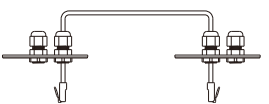

Kstar delivers a total system separately on site to client, this consists of:

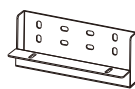
BluE-S 5000D-M1/BluE-S 3680D-M1				
				
4×M5*12	2×φ8*60	1×CT Connector	1×CT and com cable	2×AC Collector
				
2×MC4	1×Collector	1×Mounting Panel	1×User Manual	

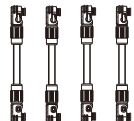
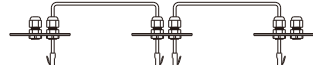
BluE-PACK5.1		
		
4×φ8*60	2×M5*12	4×M6 Gasket
		
1×Mounting Panel		

BluE-PACK10.2 (include two pieces BluE-PACK5.1)		
		
8×φ8*60	4×M5*12	2×Mounting Panel
		
8×M6 Gasket	2×Power Cable(1 black, 1 red)	1×Battery Communication Cable

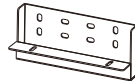
BluE-PACK15.3 (include three pieces BluE-PACK5.1)		
		
12×φ8*60	6×M5*12	3×Mounting Panel
		
12×M6 Gasket	4×Power Cable (2 black, 2 red)	1×Battery Communication Cable

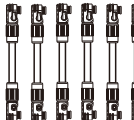
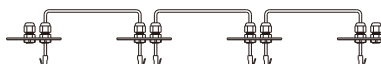
BluE-PACK20.4 (include four pieces BluE-PACK5.1)		
		
16×φ8*60	8×M5*12	4×Mounting Panel
		
16×M6 Gasket	6×Power Cable (3 black, 3 red)	1×Battery Communication Cable

1.7 System Appearance

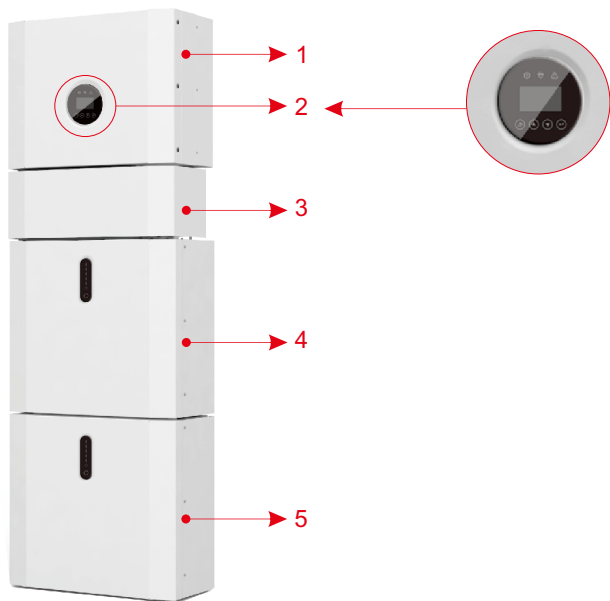

Figure 4 H5/H3 Delivery Scope

Object	Description
1	Hybrid Inverter
2	EMS Display Screen
3	Cable Box (connected to Inverter)
4	BluE-PACK5.1 (Battery 1)
5	BluE-PACK5.1 (Battery 2, if configured)

1.7.1 Cable Box Part

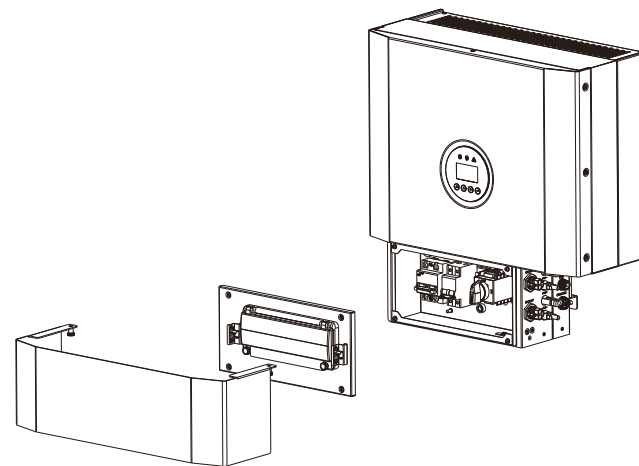

Figure 5 Inverter without Cable Box Covers- Front View

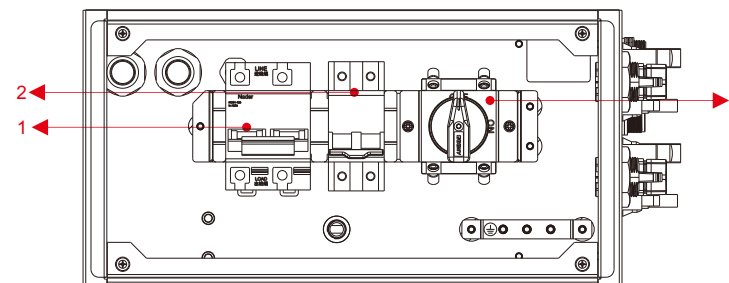

Figure 6 Cable Box Part without Covers - Front View

Object	Description
1	Battery circuit breaker
2	Output terminal block (BACK UP)
3	DC isolation switch

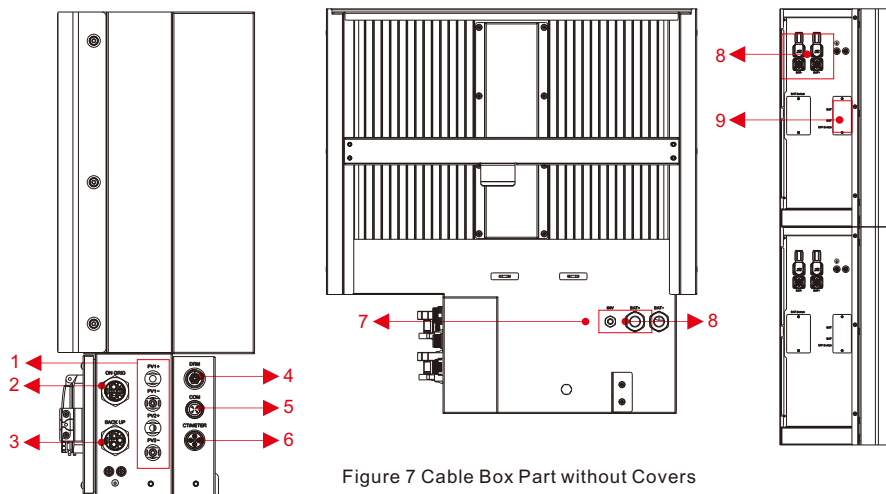

Figure 7 Cable Box Part without Covers

Object	Description	DVC class	Object	Description	DVC class
1	PV1, PV2	DVC C	2	GRID	DVC C
3	BACKUP	DVC C	4	DRM	DVC A
5	COM	DVC A	6	CT/METER	DVC A
7	INV	DVC C	8	BAT+,BAT-	DVC C
9	RJ45	DVC C			

1.8 Liability Limitation

Any product damage or property loss caused by the following conditions, Company does not assume any direct or indirect liability.

- Product modified, design changed or parts replaced without Company authorization;
- Changes, repair attempts and erasing of series number or seals by Non-Company technician;
- System design and installation are not in compliance with standards and regulations;
- Fail to comply with the local safety regulations (VDE for DE, SAA for AU);
- Transport damage (including painting scratch caused by rubbing inside packaging during shipping). A claim should be made directly to shipping or insurance company in this case as soon as the container/package is unloaded and such damage is identified;
- Fail to follow any/all of the user manual, the installation guide and the maintenance regulations;
- Improper use or misuse of the device;
- Insufficient ventilation of the device;
- The maintenance procedures relating to the product have not been followed to an acceptable standard;
- Force majeure (violent or stormy weather, lightning, overvoltage, fire etc.);
- Damages caused by any external factors.

02 Installation

This Manual introduces the basic steps to install and set up H5/H3.



NOTE:

Please be cautious unpacking the battery, otherwise components could be damaged.

2.1 Installation Site and Environment

2.1.1 General

This H5/H3 energy storage system is outdoor version and can be installed in an outdoor location.

When H5/H3 systems are installed in a room, H5/H3 must not be hampered by the structure of the building, the furnishings and equipment of the room.

The H5/H3 is naturally ventilated. The location should therefore be clean, dry and adequately ventilated. The mounting location must allow free access to the unit for installation and maintenance purposes, and the system panels must not be blocked.

The following locations are not allowed for installation:

- Habitable rooms;
- Ceiling cavities or wall cavities;
- On roofs that are not specifically considered suitable;
- Access / exit areas or under stairs / access walkways;
- Where the freezing point can be reached, such as garages, carports or other places as well as wet rooms (environmental category 2);
- Locations with humidity and condensation over 90%;
- Places where salty and humid air can penetrate;
- Seismic areas - additional security measures are required;
- Sites with altitude over 2000m;
- Places with an explosive atmosphere;
- Locations with direct sunlight or a large change in the ambient temperature;
- Places with flammable materials or gases or an explosive atmosphere.

2.1.2 Restricted Locations

The H5/H3 shall not be installed :

- In restricted locations as defined for panels in AS / NZS 3000;
- Within 600mm of any heat source, such as hot water unit, gas heater, air conditioning unit or any other appliance.
- Within 600mm of any exit;
- Within 600mm of any window or ventilation opening;
- Within 900mm of access to 240Vac connections;
- Within 600mm of side of other device.

A H5/H3 installed in any corridor, hallway, lobby or the like and leading to an emergency exit shall ensure sufficient clearance for safe egress of at least 1 meter.

The H5/H3 must also not be installed in potentially explosive atmospheres for gas cylinders that are heavier than air gases and have a vent clamp in accordance with AS / NZS 3000.

2.1.3 Barrier to Habitable Rooms

To protect against the spread of fire in living spaces where the H5/H3 is mounted or on surfaces of a wall or structure in living spaces with a H5/H3 on the other side, the wall or structure shall have a suitable non-combustible barrier. If the mounting surface itself is not made of a suitable non-combustible material, a non-combustible barrier can be placed between the H5/H3 and the surface of a wall or structure.

If the H5/H3 is mounted at a wall or at a distance of 300mm from the wall or the structure separating it from the habitable space, the distances to other structures or objects must be increased. The following distances must remain free:

- (i) 600 mm beside the H5/H3;
- (ii) 500 mm above the H5/H3;
- (iii) 600 mm before the H5/H3.

If the distance between the H5/H3 and the ceiling or any object above the system is less than 500mm, the ceiling or structural surface above the system must be made of noncombustible material within a radius of 600mm around the system.

The H5/H3 must be mounted to ensure the highest point is not more than 2.2m above the ground or the platform.

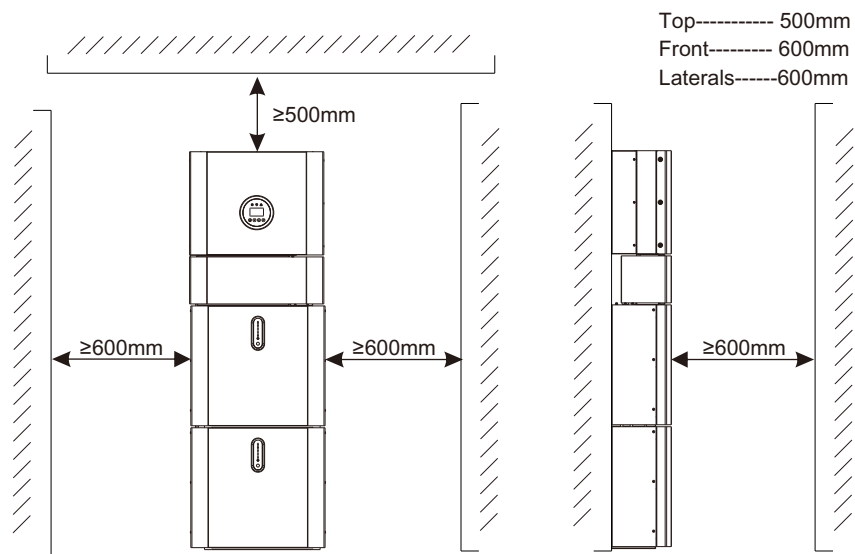

Figure 8 Limited Distance of Installation to Neighboring Objects

2.2 Installation

Step 1 Remove the battery and inverter from the packaging box.

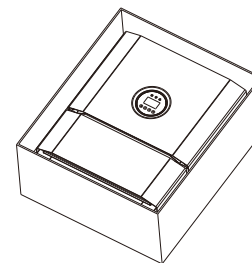

Figure 9 Unpacking the inverter and battery

2.2.1 Battery Installation

Step 2 Assemble the battery mounting panel on the battery.

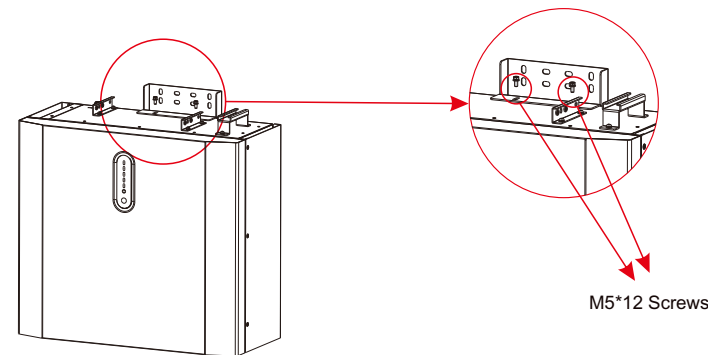

Figure 10 Assemble Battery Mounting Panel

Step 3 Position the battery parallel to the wall and use a $\Phi 8$ mm drill to drill holes at a depth of about 70mm in the wall for subsequent fixation of the mounting plates.

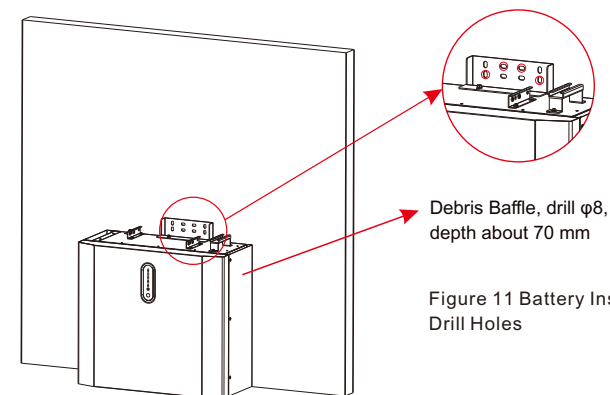

Figure 11 Battery Installation - Drill Holes



NOTE:

The type B RCD must be installed on the backup port of the system. In addition, the installation of inverter must fulfill AS/NZS 3000, AS/NZS 4777.1 and AS/NZS 5033. the internal N line of converter is connected to grid neutral via internal relays, when in stand-alone mode.

Step 4 Remove the debris baffle and secure the battery to the wall with screws and gaskets.

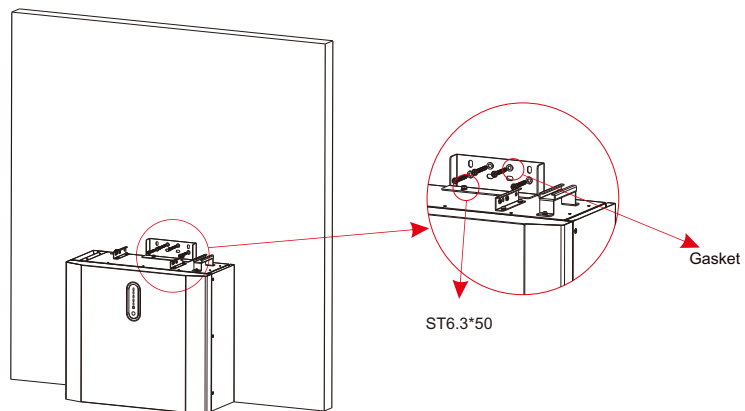

Figure 12 Battery Installation – Mounting on the Wall

Step 5 To assemble the second (and all other) battery, repeat steps 6 and 7, respectively.

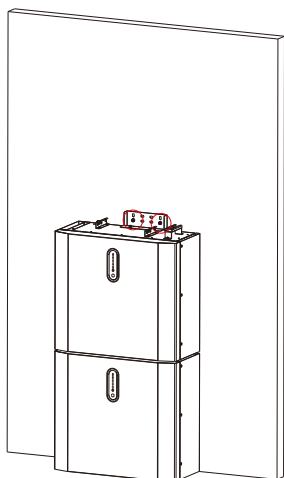

Figure 13 Battery Installation – Second Battery Installation

2.2.2 Inverter Installation

Step 6 Inverter Installation.

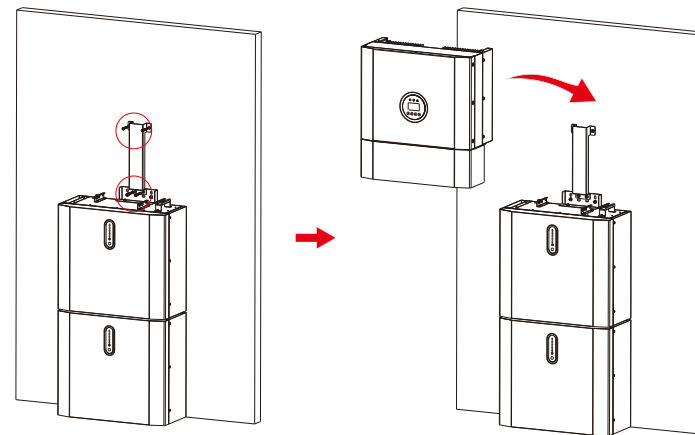

Figure 14 Inverter Installation

Step 7 Hang the inverter onto the mounting panels, adjust the entire system and ensure that the battery and the inverter have been securely hung onto the panels and brackets.

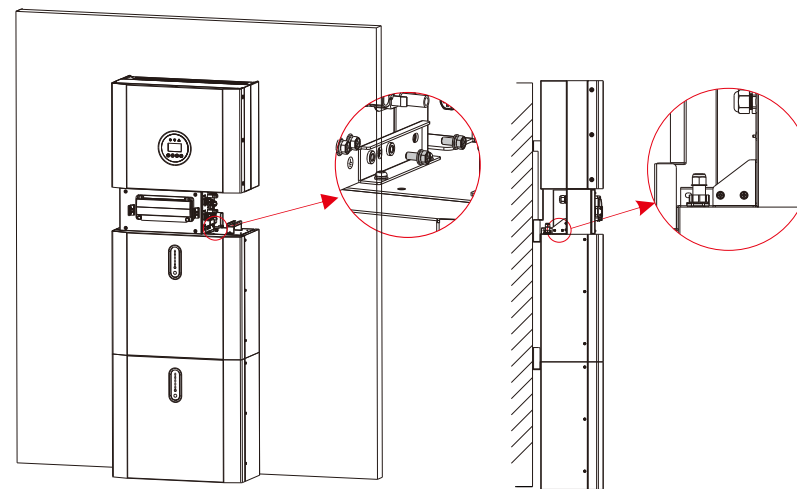

Figure 15 Inverter Installation on the Wall

Step 8 Please make AC cables on site.

Step 8-1 Please follow the AC cable requirements below.

For all AC connections, 4~10mm² 105 XJ cable is required to be used. Please make sure the resistance of cable is lower than 1 ohm. If the wire is longer than 20m, it's recommended to use 10mm² cable.

WARNING:



There are "L" "N" "⚡" symbols marked inside the connector, the Line wire of grid must be connected to "L" terminal; the neutral wire of grid must be connected to "N" terminal; the earth of grid must be connected to "⚡"

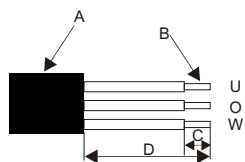

Object	Description	Value
A	External diameter	12mm to 18mm
B	Copper conductor cross-section	4mm ² to 10mm ²
C	Stripping length of the insulated conductors	approx. 13mm
D	Stripping length of the outer sheath of the AC cable	approx. 53mm

The PE conductor must be 10mm longer than the L and N conductors

b. Insert the conductor into the suitable ferrule acc. to DIN 46228-4 and crimp the contact.

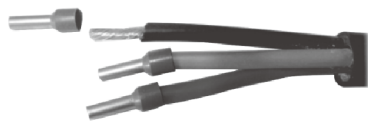

b

c. Unscrew the swivel nut from the threaded sleeve and thread the swivel nut and threaded sleeve over the AC cable.

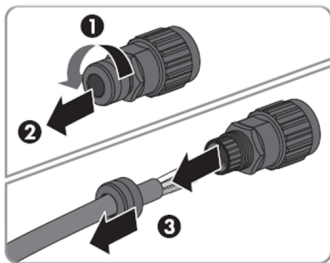

c

d. Insert the crimped conductors L, N and PE into the corresponding terminals and tighten the screw with a hex key wrench screw driver(size:2.5, 1.2~2.0 N.m). Ensure that all conductors are securely in place in the screw terminals on the bush insert.

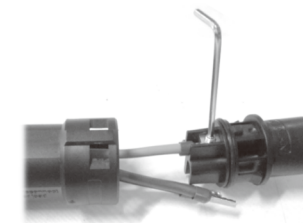

d

e. Screw the swivel nut onto the threaded sleeve. This seals the AC connector and provides strain relief for the AC cable. When doing so, hold the bush insert firmly by the locking cap. This ensures that the swivel nut can be screwed firmly onto the threaded sleeve.

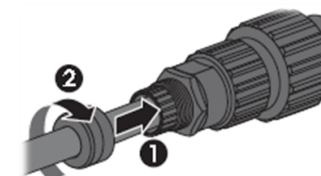

e

f. Assemble the plug shell ,adapter as below picture, Push the adapter and Shell by hand until a "Click" is heard or felt.

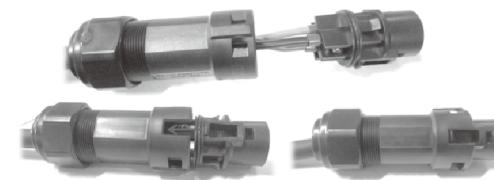

f

g. Plug the AC connector into the jack for the AC connection by hand until a "Click" is heard or felt.

(8) Use tool to clamp the AC wiring terminal and wire rod; screw the nut, but do not tighten it. Make sure that the cable is free to pass through the waterproof components. Once the terminal is connected to the right site of the inverter, tighten the nut.

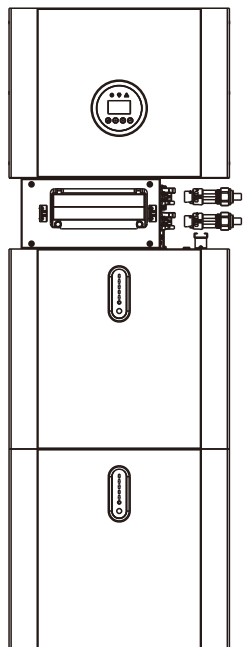

Figure 16

(9) Connect the AC wiring terminal to the corresponding hole site of the inverter and lock it with a screw driver or electric screw driver (suggestion: stem diameters and torsion of screwdriver or electric screwdriver should be 4mm and 8~12kg-f.cm respectively)

(10) Tighten the nut.

(11) Circuit breaker parameters are recommended:

- Back-up 32A/400Vac 6KA
- On-grid 40A/400Vac 6KA

Step 8-2 Connect the Backup and Grid cables in advance according to the connector mode, and connect them to the Backup and Grid board connectors in turn.

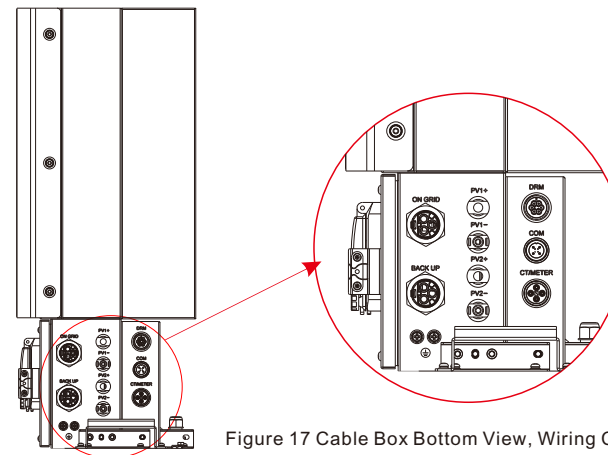

Figure 17 Cable Box Bottom View, Wiring Connectors

Step 9 Take out the communication cable set provided in the accessory parts of one H5/H3-BAT, cut off one end and crimp a new RJ45 connector.

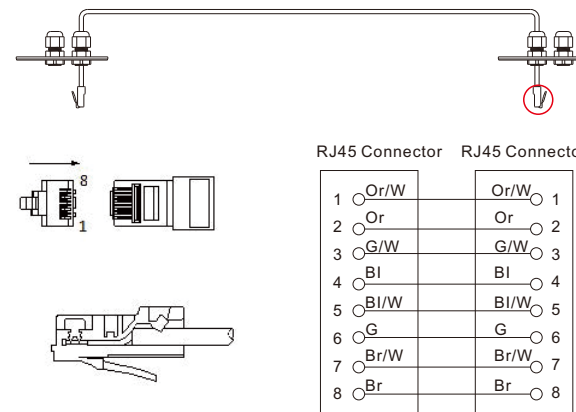

Figure 18 Network Cable Type B

! NOTE:

The communication cable is in type B, see Figure 18. Leave the power cables and communication cables hanging on outside. Leave the device aside.

Step10 Connect the BAT communication cable of the cable box from Step 13 to the topmost battery at the right side. Then use the communication cable supplied with the batteries to connect the batteries to each other via the respective connectors on the left side. After you have connected all the modules together, close all covers (if you want to connect further battery modules, you must mount them before closing).

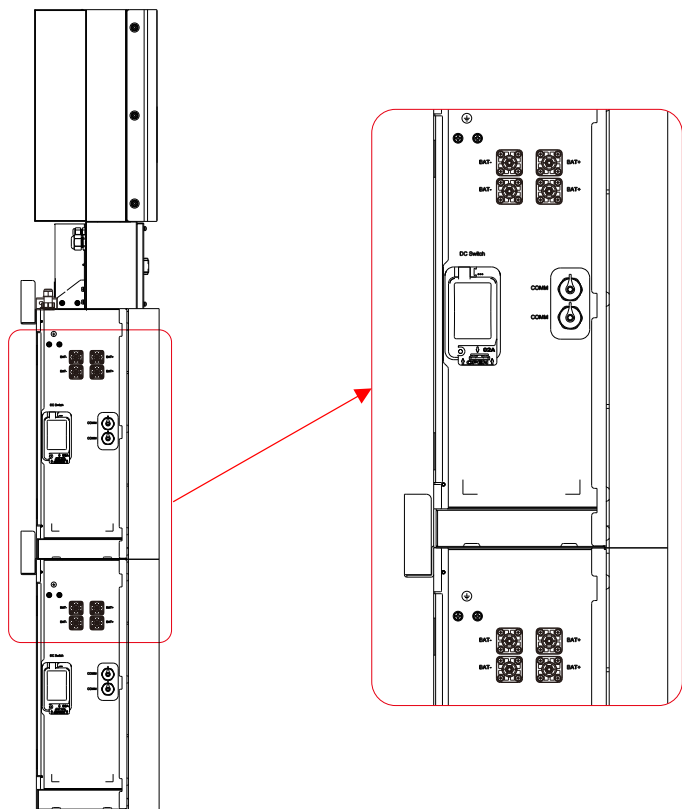

Figure 19 Wiring the Communication Cable

Step11 Connect the power cables of the bottom battery from Step 4 to the side terminals of the top battery. Make sure that red connects to red and black connects to black.

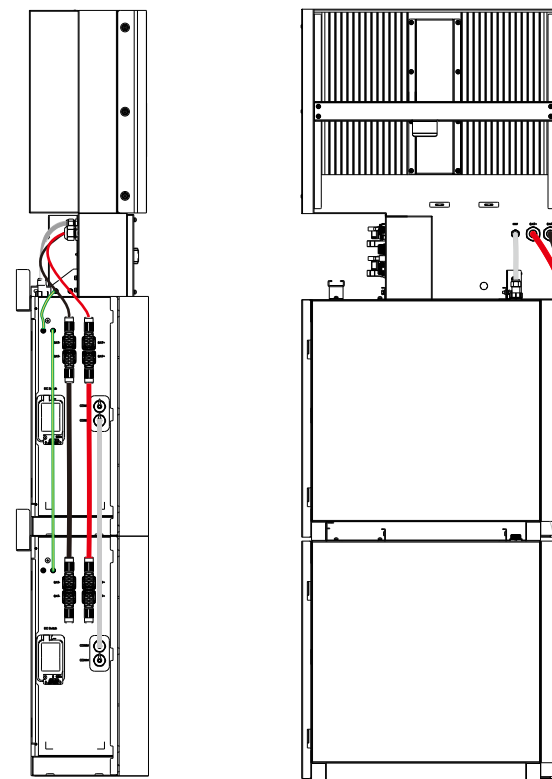

Figure 20 Wiring the Battery Power Cable

Step12 Close the battery covers and connect the PV-MC4 connectors to the system (connection on both sides). Also, connect all AC cables, the meter communications cable METER, and the Ethernet cable LAN. Then close the cable box cover. The installation is now complete.

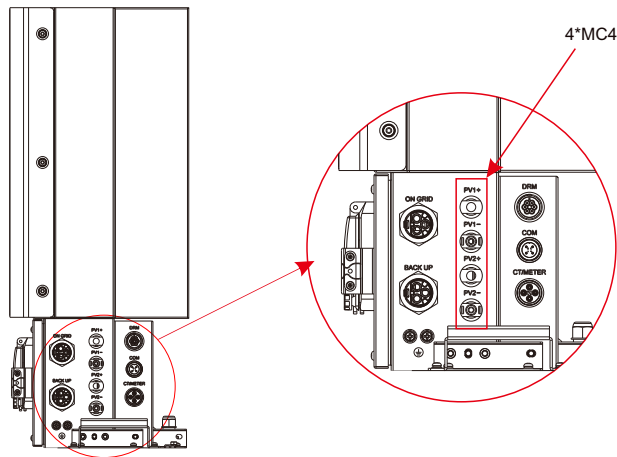

Figure 21 PV Wiring

Step13 Close the lid and tighten the screw.

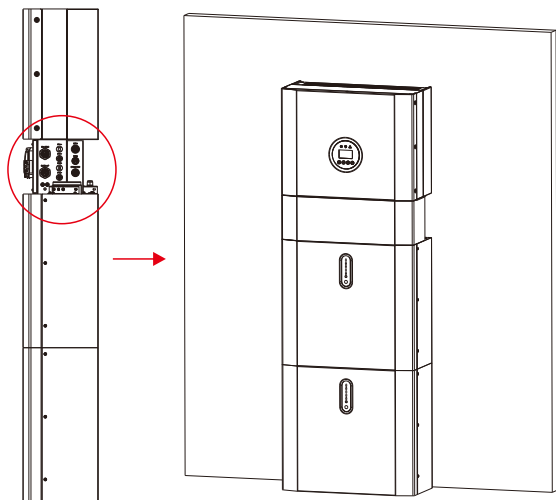

Figure 22

If you connect more than 2 battery modules to the system, please only install the additional batteries 3~4 on the side of the system. You can connect up to 4 batteries, 2 each mounted on top of each other, to the H5/H3. To do this, carry out the individual installation steps as for the first two batteries, including the DIP setting on the last module.

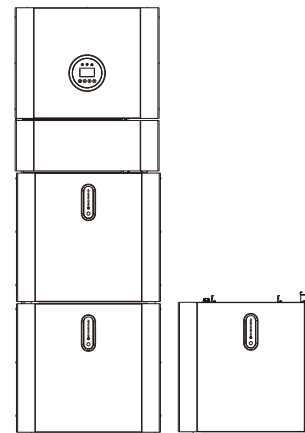

Figure 23 Increase the Battery Modules



NOTE:

Recommended AC circuit breaker rating is 32A.



NOTE:

It is necessary to disconnect the power line, communication line and communication line between battery pack and inverter to manually sleep all battery packs.



STATEMENT:

The method of anti-islanding protection is Power variation

2.3 External CT connection

The electricity meter should be mounted and connected at the grid transition point (feed-in point) so that it can measure the grid reference and feed-in power.

1. Loosen the nut, and untangle the single-aperture sealing ring.

Pin	Description	Pin	Description
1	CT positive electrode(White)	3	RS485-A
2	CT negative pole(Black)	4	RS485-B

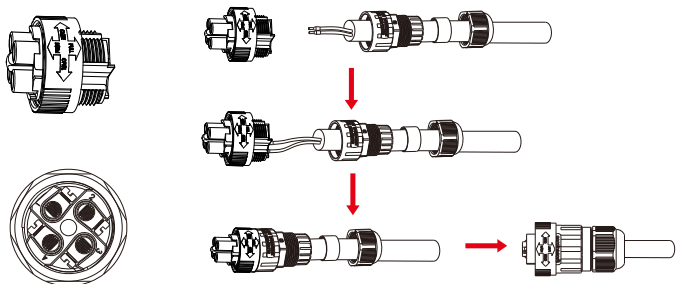
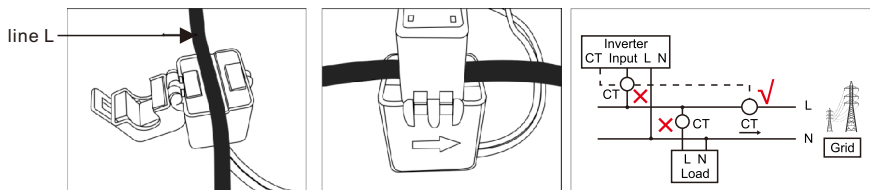

Figure 24

2. Install the waterproof component and screw on the waterproof sheath nut.

3. Open the external CT wiring port, the arrow points to the direction of the power grid, put the wire into the external CT card slot, and buckle the buckle.



NOTE:
 External CT should be placed near the power grid.
 If CT test pass but inverter still can't achieve export power (power is not controllable or always 0 power output). Please check installation location of the CT.

2.4 DRED port connections(optional)

DRED means demand response enable device. The AS/NZS 4777.2:2015 required inverter need to support demand response mode(DRM). This function is for inverter that comply with AS/NZS 4777.2:2015 standard. Inverter is fully comply with all DRM. A 6P terminal is used for DRM connection.

Pin	Description	Pin	Description
1	DRM 1/5	4	DRM 4/8
2	DRM 2/6	5	RefGen
3	DRM 3/7	6	Com/DRM 0

Please follow below figure to assemble DRM connector.

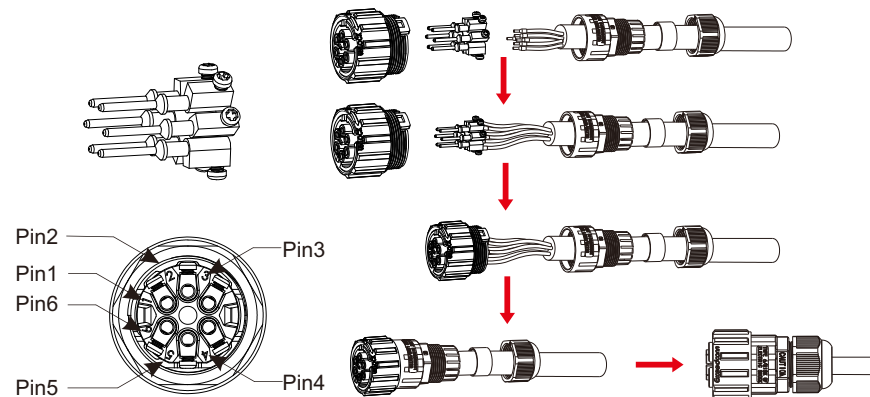

Figure 25 DRM connector

2.5 Single Line Diagram

The single line diagrams of DC-, AC- and Hybrid-coupled system are as below:

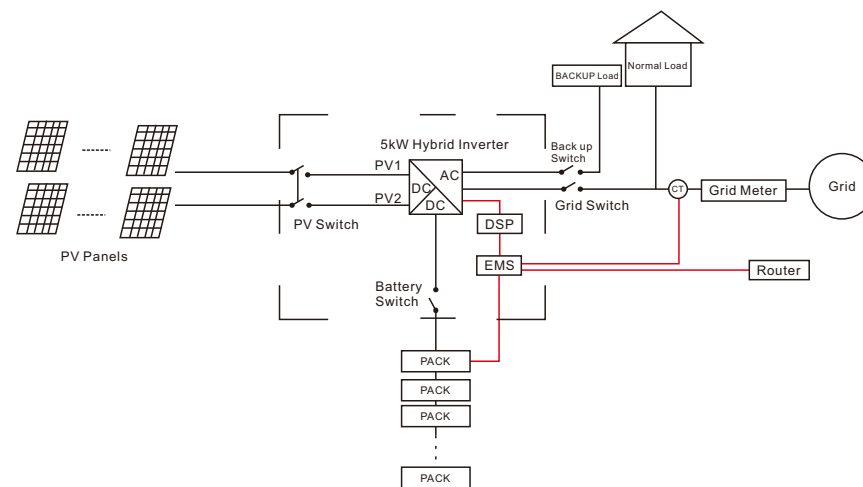

Figure 26 DC-coupled system

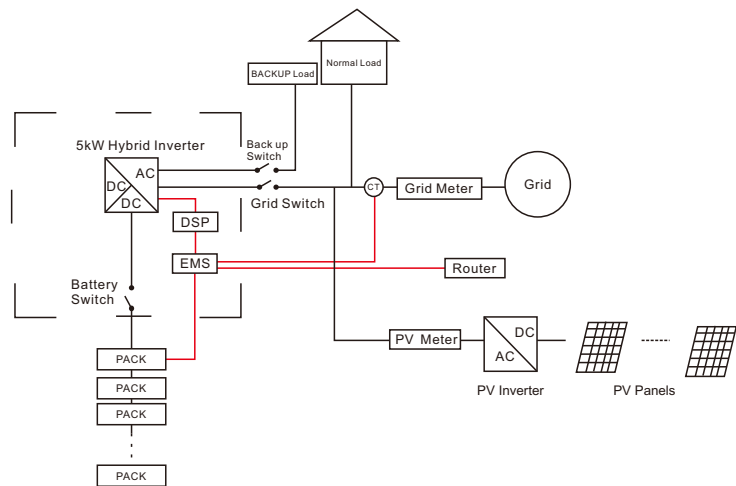

Figure 27 AC-coupled system

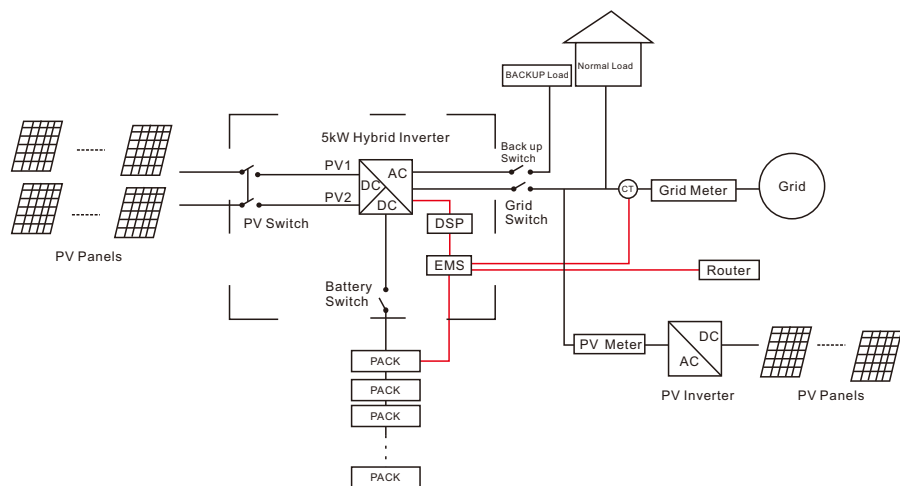

Figure 28 Hybrid-coupled system

03 System Operation

3.1 Switch On

When turning on the system, it is very important to follow the steps below to prevent damage to the system.

WARNING: Please check the installation again before turning on the system.

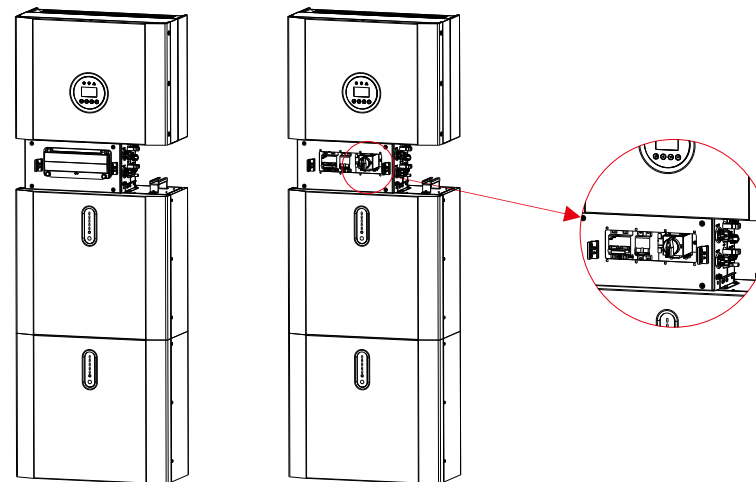

Step 1: Turn on the external PV switch.

Step 2: Turn on the external grid switch.

Step 3: If backup load is applied, turn on the external Backup switch.



NOTE:

the Backup switch is only used when a backup load is applied.

Step 4: Open the outer shell of the cable box. Open the battery switch cover and turn on the battery switch on the cable box.

Step 5: Press power button on all the batteries until the indicator lights turn on.

Step 6: Close the battery switch cover and the outer shell of the cable box.

3.2 Switch Off

- Step 1:** Press the power button on all the batteries, till the lights turn off.
- Step 2:** Open cable box outer shell, open the battery switch cover and turn off the battery switch.
- Step 3:** Turn off the external grid switch.
- Step 4:** If backup load is applied, turn off the external backup switch.
- Step 5:** Turn off the external PV switch on the cable box.
- Step 6:** Close the battery switch cover and the outer shell of cable box.

3.3 Emergency Procedure

When the H5/H3 energy storage system appears to be running abnormally, you can turn off the grid-connected main switch that directly feeding the BESS, and turn off all load switches within the BESS, turn off the battery switch at the same time. To prevent a potentially fatal personal injury, if you want to repair or open the machine after the power is switched off, please measure the voltage at the input terminals with a suitably calibrated voltage tester.

Before working on this equipment, please confirm that there is no grid electric supply to the BESS! The upper cover plate cannot be opened until the DC-link capacitance inside the battery modules discharges completely about 15 minutes later.

3.3.1 Emergency Handling Plan

1. Disconnect the AC breaker.
2. Check the control power supply. If it is OK, return the power supply to find out the reason.
3. Please record every detail related to the fault, so Company can analyse and solve the fault. Any operation of equipment during a fault is strictly forbidden, please contact Company as soon as possible.
4. As battery cells contain a little Oxygen inside and all cells have got explosion-proof valves, explosion hardly happens.
5. When the indicator light on the battery shows a red fault, check the fault type through the communication protocol, and contact our after-sales service personnel for advice.

3.3.2 Hazards

If the battery pack leaks electrolyte, avoid contact with the leaking liquid or gas. If one is exposed to the leaked substance, immediately perform the actions described below:

Inhalation: Evacuate the contaminated area, and seek medical attention.

Eye contact: Rinse eyes with running water for 5 minutes, and seek medical attention.

Contact with skin: Wash the affected area thoroughly with soap and water, and seek medical attention.

Ingestion: Induce vomiting and seek medical attention.

3.3.3 Fire

If a fire breaks out in the place where the battery pack is installed, perform the following countermeasures:

Fire extinguishing media

During normal operation, no respirator is required. Burning batteries can not be extinguished with a regular fire extinguisher, this requires special fire extinguishers such as the Novec 1230, the FM-200 or a dioxin extinguisher. If the fire is not from a battery, normal ABC fire extinguishers can be used for extinguishing.

Fire -fighting instructions

1. If fire occurs when charging batteries, if it is safe to do so, disconnect the battery pack circuit breaker to shut off the power to charge.
2. If the battery pack is not on fire yet, extinguish the fire before the battery pack catches fire.
3. If the battery pack is on fire, do not try to extinguish but evacuate people immediately.



There may be a possible explosion when batteries are heated above 150°C. When the battery pack is burning, it leaks poisonous gases. Do not approach.

Effective ways to deal with accidents

Battery in dry environment: Place damaged battery into a segregated place and call local fire department or service engineer.

Battery in wet environment: Stay out of the water and don't touch anything if any part of the battery, inverter, or wiring is submerged.

Do not use a submerged battery again and contact the service engineer.

04 EMS Introduction and Set up

4.1 Function Description

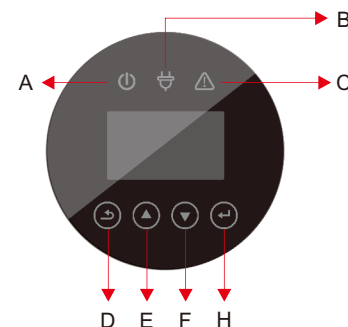

Figure 29 H5/H3 EMS Interface

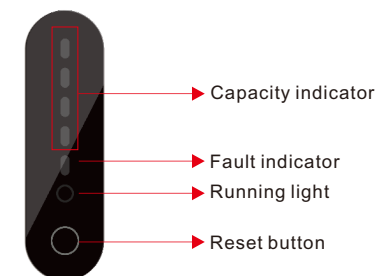

Figure 30 PACK Interface

Object	Name	Description
A	Indicator LED	Grid connection
B		Off-grid
C		Red: The inverter is in fault.
D	Button Function	Return Button: Escape from current interface or function.
E		Up button: Move cursor to upside or increase value.
F		Down Button: Move cursor to downside or decrease value.
H		ENT Button: Confirm the selection.

LED indicator description

Table 4.1 LED working status indication

status	Normal/Alarm/Protection	ON/OFF	RUN	ALM	Power indicator LED					Instructions	
		●	●	●	●	●	●	●	●		
Shut down	dormancy	off	off	off	off	off	off	off	off	off	All off
Standby	Normal	light	Flash one time	off	According to battery indicator					standby mode	
	Alarm	light	Flash one time	Flash three times	According to battery indicator					Module low voltage	
charge	Normal	light	light	off	According to battery indicator (Power indicator highest LED flashes two)					The maximum power LED flashes twice, and the ALM does not flash when an overcharge alarm occurs	
	Alarm	light	light	Flash three times	light	light	light	light	light	light	If there is no mains electricity, the indicator light turns to standby
	Overcharge protection	light	light	off	light	light	light	light	light	light	Stop charging
Discharge	Temperature, overcurrent, failure, protection	light	off	light	off	off	off	off	off	off	Stop charging
	Normal	light	Flash three times	off	According to battery indicator						
	Alarm	light	Flash three times	Flash three times	off	off	off	off	off	off	Stop discharging
Failure	Undervoltage protection	light	off	off	off	off	off	off	off	off	Stop discharging
	Temperature, overcurrent, short circuit, reverse connection, failure protection	light	off	light	off	off	off	off	off	off	Stop charging and discharging

4.2. Display and Setting

4.2.1 PV1 input display interface

Interface

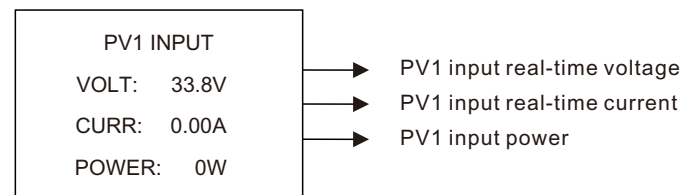

4.2.2 PV2 input display interface

Interface

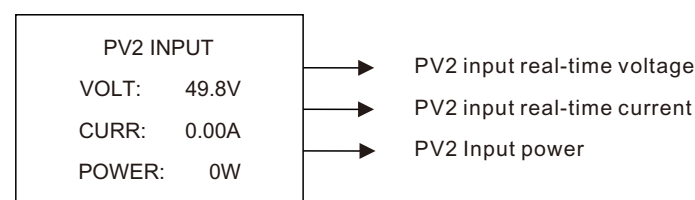

4.2.3 Bus voltage

Interface

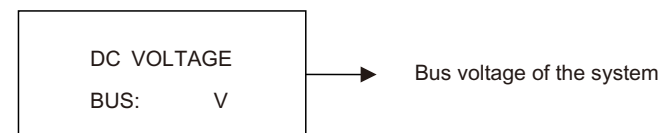

4.2.4 Battery

Interface

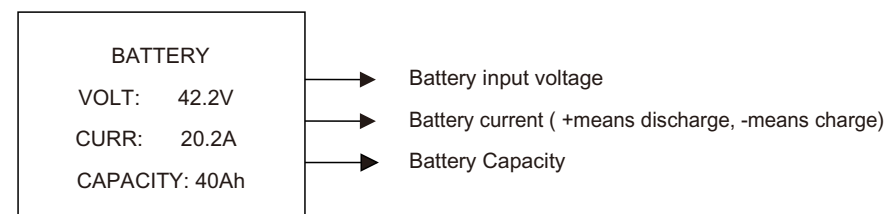

4.2.5 Battery Prmeter

Interface

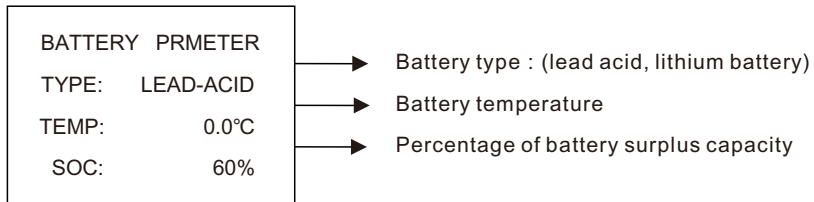

4.2.6 BMS parameters

Interface

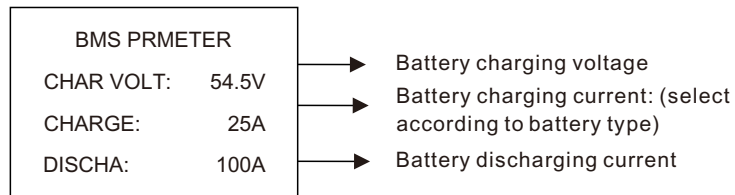

4.2.7 Grid-connected output

Interface

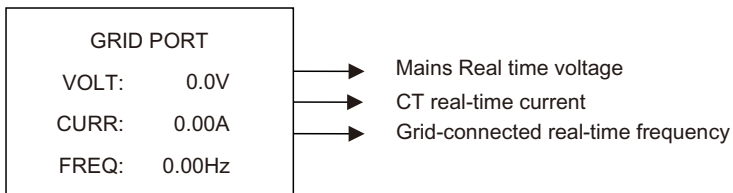

4.2.8 Inverter output

Interface

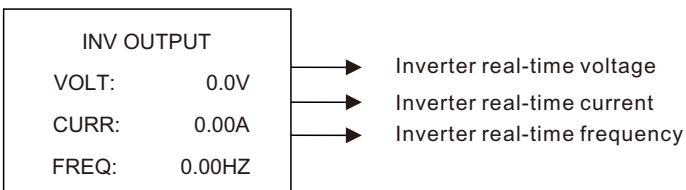

4.2.9 Load

Interface

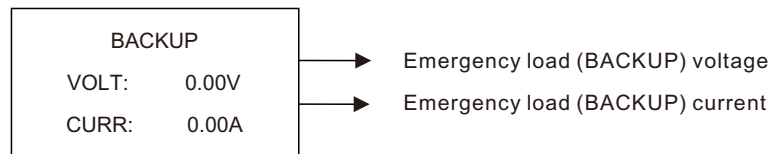

4.2.10 Power

Interface

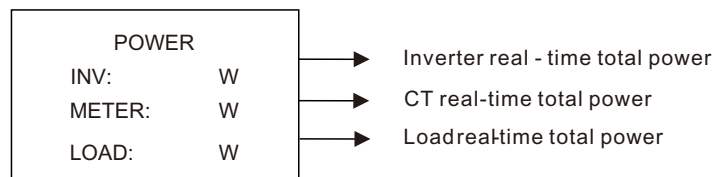

4.2.11 Power

Interface

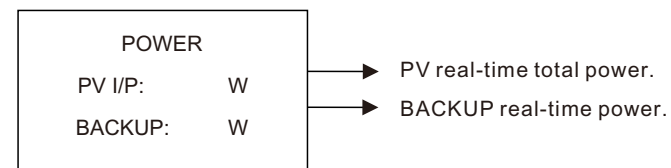

4.2.12 Temperature

Interface

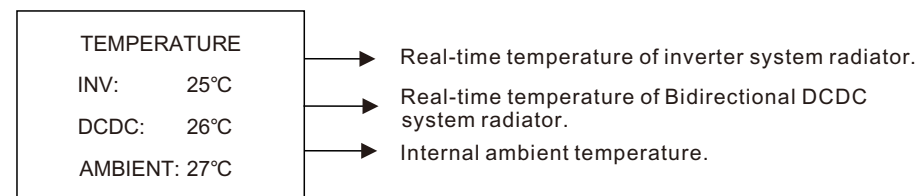

4.2.13 Status information

Interface	Description
<div style="border: 1px solid black; padding: 5px; width: fit-content;"> <p style="text-align: center;">STATE</p> <p>SYS: ERROR</p> <p>INV: STANDBY</p> <p>DCDC: STANDBY</p> </div>	<p>System information:Power-up mode, standby mode, hybrid grid-connection, off-grid operation, mains charging mode, PV charging mode, bypass mode, fault mode, DSP programming, ARM programming.</p> <p>INV: standby mode, off-grid inverter mode, grid-connected mode, and transition of grid-connection to off-grid, transition of off-grid to grid mode.</p> <p>DCDC: standby mode, soft start mode, charging mode,discharging mode.</p>

4.2.14 Error information

Interface	Description
<div style="border: 1px solid black; padding: 5px; width: fit-content;"> <p style="text-align: center;">ERROR NO.</p> <p>WARNING: W11-1</p> <p>FAULT: F10-1</p> </div>	<p>Alarm code (see Chapter 9)</p> <p>Error code (see Chapter 9)</p>

4.2.15 System setting

Interface	Description
<div style="border: 1px solid black; padding: 5px; width: fit-content;"> <p style="text-align: center;">SYSTEM</p> <p>STATE: PEAKS HIFT</p> <p>GRID STD: China</p> <p>PV I/P: INDEPN</p> </div>	<p>Status mode: Self-generation and self-consumption , Peak load shifting , and Battery priority.</p> <p>Grid-connection standards: China, Germany, Australia, Italy, Spain, UK, Hungary, Belgium, Western Australia, Greece, France, Bangkok, Thailand, local and 60Hz.</p> <p>PV input mode:independent connection , parallel connection , constant voltage.</p>

Press ESC button to enter user setting

4.2.16 User setting

Interface	Description
<div style="border: 1px solid black; padding: 5px; width: fit-content;"> <p style="text-align: center;">-USER-</p> <p>→1:SETUP</p> <p>2:INQUIRE</p> <p>3:STATISTIC</p> </div>	<p>Press ESC on the Main Display Interface to enter the user interface.</p> <p>See chapter 8.2 for more setting details.</p>

Enter the password before setting up the user.

Interface	Description
<div style="border: 1px solid black; padding: 5px; width: fit-content;"> <p style="text-align: center;">-PASSWORD-</p> <p>INPUT: XXXXX</p> </div>	<p>After entering the setup interface, the system will prompt to input password; The default password is“000000”, which can be altered in Password setting menu; Press UP/DOWN button to increase or decrease the figure that is input; Press ENTER button to move the cursor backwards or confirm the setting; Press ESC button to move the cursor forward.</p>

4.3 Setting

Interface	Description
<div style="border: 1px solid black; padding: 5px; width: fit-content;"> <p style="text-align: center;">--SETUP--</p> <p>→1:SYS SETTING</p> <p>2:BAT SETTING</p> <p>3:GRID STD</p> <p>4:RUN SETTING</p> <p>5:485 ADDRESS</p> <p>6:BAUD RATE</p> <p>7:LANGUAGE</p> <p>8:BACKLIGHT</p> <p>9:DATE/TIME</p> <p>10:CLEAR REC</p> <p>11:PASSWORD</p> <p>12:MAINTENANCE</p> <p>13:FCTRY RESET</p> <p>14:AUTO TEST</p> </div>	<p>This interface is used for various information inquiry options.</p> <p>Press UP/DOWN button to move the corresponding options.</p> <p>Press ENTER to enter the selected menu.</p> <p>Press ESC button to return to the user interface.</p> <p>There are 16 options in total, including system mode, battery parameters, grid standard, operation parameters, 485 address, 485 baud rate, language display, LCD backlight, date/time, clear history, password setting and maintenance, and factory setting,AUTO TEST.</p>

4.3.1 System setting

Interface	Description
<pre>--SYS SETTING-- →1:WORK MODE 2:PV INPUT 3:ZERO EXPORT 4:DRM ENABLE 5:EPS ENABLE 6:REMOTE CTRL 7:START DELAY 8:CEI SPI CTRL 9:GFCICLK ENB 10:DISC MODE 11:DISCHDEPTH 12:GENERATOR 13:CT OR METER 14:AC COUPLE 15:CT Directio 16:ISLAND</pre>	<p>This interface is used to access system information. Press UP/DOWN button to move corresponding options. Press ENTER to enter the selected menu. Press ESC button to return to the setting interface. There are 16 options in total, including working mode, PV input type, anti-reflux enable, DRM enable, EPS enable, remote controlled enable, boot delay time. (see from 1 to 16)</p>

① Working mode

Interface	Description
<pre>--WORKE MODE -- 1:SELF CONSUME → 2:PEAK SFT 3:BAT PRIORITY</pre>	<p>This interface is used to opt for the working mode. After selecting the three modes, the restart interface will be entered. Press ESC button to return to setting interface.</p>

After completing the setup of peak load shifting mode, the time for charging and discharging also needs to be set.

Interface	Description
<pre>-- SELF CONSUME -- 1:DISABLE →2:ENABLE</pre>	<p>1.DISABLE 2.ENABLE After selecting Allow, the charging time setting page is displayed.</p>

```
--CHARGE TIME--
00:00-23:59
MAX SOC:100%
```

- 1.Self-consumption mode disables grid charging: Battery pack can only be charged by PV.
- 2.Self-consumption mode enables grid charging: Grid charges battery pack until MAX SOC during set time.

Time setup

Interface	Description
<pre>CHA STAR1: 00:00 CHA REND1: 00:00 DIS START1: 00:00 DISC END1: 00:00</pre>	<p>This interface is used to set the time-1 of peak load shifting. Press UP/DOWN button to change the value. Press ENTER to confirm. Press ESC button to return.</p>
<pre>CHA STAR2: 00:00 CHA REND2: 00:00 DIS START2: 00:00 DISC END2: 00:00</pre>	<p>This interface is used to set the time-2 of peak load shifting. Press UP/DOWN button to change the value. Press ENTER to confirm. Press ESC button to return.</p>

② Input mode

Interface	Description
<pre>--INPUT MODE -- →1:INDEPENDANT 2:PARALLEL 3:CV</pre>	<p>Setup of PV Input mode. The factory setting by default is standalone mode. When parallel input is set to be stand-alone mode, PV power will be imbalanced.</p>

INDEPENDANT:2 PV lines are separate or only one PV input.
 PARALLEL:2 PV lines are in parallel, with positive and negative input lines connected together.
 CV:The input is constant voltage source instead of PV.

③ ZERO EXPORT

Interface	Description
<pre>-- ZERO EXPORT -- →1:DISABLE 2:ENABLE</pre>	<p>Back-flow-prevention function. Default option is disabling.</p>

④ DRM enable

(For Australia only)

Interface	Description
--DRM ENABLE-- →1:DISABLE 2:ENABLE	It is enabled when BACKUP load needs power. Default option is disabling.

⑤ Backup enable

Interface	Description
--EPS ENABLE-- →1:DISABLE 2:ENABLE	It is enabled when BACKUP load needs power. Default option is Enabling.

⑥ Remote Control enable

Interface	Description
--REMOTE CTRL-- →1:DISABLE 2:ENABLE	The power switch of the machine can be realized through remote control. Default option is disabling.

⑦ START-UP delay

Interface	Description
START-UP DELAY INPUT: 30 UNIT: SEC	The input value ranges from 20 to 300, which varies with different standards.

⑧ CEI SPI CTRL (For Italy only)

Interface	Description
-CEI SPI CTRL- →1.DISABLE 2.ENABLE	CEI SPI CTRL:(1. Disable 2. Enable) When the DRM signal is enabled, this is used as a local signal. When the DRM signal is enabled, when the CEI SPI Ctrl is enabled, the frequency range is 50.2Hz ~ 49.8Hz. When the CEI SPI Ctrl is disabled, the frequency range is 51.5Hz ~ 49.8Hz

⑨ GFCICHK ENB

Interface	Description
-GFCICHK ENB- 1.DISABLE →2.ENABLE	GFCICHK ENB(1. Disable 2. Enable) PV leakage protection enable Leakage current detection function

⑩ DISC MODE

Interface	Description
-DISC MODE- →1.RATED POWER 2.LOAD PRIO	DISC MODE(1.Rated Power, 2. Load Prio) This is only for test.

⑪ DISCHGDEPTH

Interface	Description
-DISCHGDEPTH- 1.DISABLE →2.ENABLE	Discharge depth enable (1. Disable 2. Enable) : enable discharge depth. When the SOC of the battery is less than the discharge depth set by 1 -, the battery will no longer discharge, and alarm the low capacity of W13 battery. Set the discharge depth in the battery parameter setting.

⑫ GENERATOR

Interface	Description
-GENERATOR- 1.DISABLE →2.ENABLE	Generator mode enabling (1. Disable 2. Enable) when the generator needs to be connected for AC measurement, the enabling generator mode is prohibited, and the generator mode is prohibited in other times. In the mode of enabling generator, the frequency protection range measured by AC will be relaxed to + -10%, the frequency protection range at 50Hz is 45Hz~55Hz, and that of 60Hz is 54Hz~66Hz.

Enable this function when a generator is connected, then the frequency and voltage protection range of the grid gets wider.

After enabling it,remember to enable zero export and disable overfrequency derating and overvoltage derating.

⑬ CT OR METER

Interface	Description
-CT OR METER- 1.CT →2.METER	CT or meter (1.CT 2.meter): the energy storage inverter supports the connection of three-phase ammeter. Replace CT with three-phase ammeter to detect the utility power. When connecting three-phase ammeter, select "ammeter" option, and when connecting CT, select "CT" option

⑭ AC COUPLE

Interface	Description
-AC COUPLE- 1.DISABLE →2.ENABLE	When BluE ESS connects to other inverter by AC side,with other inverter charging BluE-PACK , please enable AC couple.

⑮ CT DIRECTION

Interface	Description
-CT DIRECTION- →1.POSITIVE 2.NEGATIVE	If the CT connection is reversed, there is no need to change the direction actually but only set the direction on the interface by changing 1.POSITIVE to 2.NEGATIVE or 2.NEGATIVE to 1.POSITIVE ,which is equivalent to changing the direction of the CT wiring . For example, when the battery is being charged and the grid power is positive "+", it means the CT connection is reversed. If the CT direction is 1. POSITIVE on the LCD, set it to 2. NEGATIVE, then the grid power will become negative "-".

⑯ ISLAND

Interface	Description
-ISLAND- 1.DISANLE →2.ENABLE	1.Disabled to judge island 2.Allow to judge island

4.3.2 Battery parameters

Interface	Description
--BAT SETTING-- → 1:BAT TYPE 2:DISC-DEPTH 3:OFF GRID DOD 4:CHG CURR 5:DISC POWER 6:CHG POWER 7:BAT END VOLT 8:BAT WAKE-UP 9:HEATING FLIM 10:BMS DOD 11:Maintain SOC 12:FORCE WAKE	This interface is used to select battery parameters. Press UP/DOWN button to move corresponding options; Press ENTER button to enter the selected menu; Press ESC button to return to setting interface. (see from 1 to 12)

① BATTERY TYPE

Interface	Description
--BAT TYPE-- 1:LEAD-ACID →2:LFP 3:BYD-LEP 4:CITIC-LEP 5:PYLON-LEP 6:BluE-LEP 7:KSTAR-LEP	This interface is used to select battery type. Press UP/DOWN button to move corresponding options; Press ENTER button to enter the selected menu; Select the LEAD-ACID enter button to enter the LEAD-ACID interface; Select the LFP enter button to enter the LFP interface; Select the other selections enter button to enter the restart interface.

Lead-acid battery parameter

Interface	Description
<pre>--LEAD-ACID -- →1:CHARG-VOLT 2:EQUAL VOLT 3:BAT CAP 4:BAT OVP</pre>	<p>This interface is used to select other Li battery parameter.</p> <p>Press UP/DOWN button to move corresponding options;</p> <p>Press ENTER button to enter the selected menu;</p> <p>Options include battery charge voltage, battery capacity, battery discharge end voltage, battery over voltage protection .(see from④to⑦)</p>

② Discharge depth

Interface	Description
<pre>--DISC DEPTH-- INPUT: 60 UNIT: %</pre>	<p>Press UP/DOWN to increase or decrease the input figure;</p> <p>Press Enter to move cursor backward, confirm input and return to battery parameters interface;</p> <p>Press ESC to move cursor forward and return to battery parameters interface;</p> <p>The value ranges between 10% and 100%.</p>

③ OFF GRID DOD

Interface	Description
<pre>--OFF GRID DOD-- Input : 0~100% Default : 90%</pre>	<p>Off grid discharge depth: the maximum allowable discharge depth of the machine off grid in case of mains power failure. For example, if the off grid discharge depth is set to 90%, when the machine is off grid in case of mains power failure, when the SOC of the battery is less than or equal to 10%, the inverter stops off grid operation.</p> <p>Grid connected discharge depth: in the presence of mains power, the normal grid connection of the machine is the maximum allowable discharge depth. For example, if the grid connected discharge depth is set to 80%, when the normal grid connection of mains power is allowed, when the SOC of the battery is lower than or equal to 20%, the battery will stop discharging and the discharge power will be zero.</p> <p>Relationship between off grid discharge depth and grid connected discharge depth. Grid connected discharge depth < off grid discharge depth. Off grid discharge depth - grid connected discharge depth = off grid standby SOC. For example, if the grid connected discharge depth is set to 80% and the off grid discharge depth is set to 90%, the battery will stop discharging if the SOC is equal to or lower than 20% under normal grid connected conditions. When the mains power is off, the inverter will run off grid, At this time, 10% SOC of the battery can supply power to important loads until soc10% and the inverter stops working</p>

④ Charge current

Interface	Description
<pre>--CHARGE CURR-- INPUT: 25 UNIT: A</pre>	<p>Press UP/DOWN button to increase or decrease the input figure;</p> <p>Press Enter to move cursor backward, confirm input and return to battery parameters interface;</p> <p>Press ESC button to move cursor forward and return to battery parameters interface.</p>

⑤ Discharge Power

Interface	Description
<pre>--DISC PERCENT-- INPUT: 080%</pre>	<p>Press UP/DOWN button to increase or decrease the input figure;</p> <p>Press Enter button to move cursor backward, confirm input and return to battery parameters interface;</p> <p>Press ESC button to move cursor forward and return to battery parameters interface.</p>

⑥ Charge Power

Interface	Description
<pre>--CHAR PERCENT-- INPUT: 020%</pre>	<p>Press UP/DOWN button to increase or decrease the input figure;</p> <p>Press Enter to move cursor backward, confirm input and return to battery parameters interface;</p> <p>Press ESC button to move cursor forward and return to battery parameters interface.</p>

⑦ BAT END VOLT

Interface	Description
<pre>--BAT END VOLT-- INPUT: 43.2 UNIT: V</pre>	<p>This function is used to set the discharge cut-off voltage. When select the battery type as BluE-LFP , the default value is 43.0 V and the setting range is between 40.0 V to 48.0 V.</p>

⑧ BAT WAKE-UP

Interface	Description
<pre>-- BAT WAKE-UP-- →1:ENABLE 2:TIME</pre>	<p>Enter the option 1 to enable or disable the function. Enter the option 2 to adjust the value of the time.</p>

Battery wake up enable

Interface	Description
<pre>--BAT WAKE-UP-- →1:DISABLE 2:ENABLE</pre>	<p>Battery wake-up enable setting. The default option is disabling.</p>

Bat Wake Time

Interface	Description
<pre>-- Bat Wake Time-- INPUT: 060min</pre>	<p>Press UP/DOWN button to increase or decrease the input figure; Press Enter button to move cursor backward, confirm input and return to battery parameters interface;</p>

⑨ HEATING FLIM

Interface	Description
<pre>--HEATING FLIM-- →1:ENABLE 2:TIME</pre>	<p>Battery heating module control command 1. Automatic enable: Automatically enable or disable the heating film according to the cell temperature and charging requirements 2. Manually enable: When the cell temperature meets the conditions of enabling the heating film and the SOC is over 30%, then enable the heating film. 3. Manually disable: Manually disable the heating film immediately and unconditionally.</p>

⑩ BMS DOD

Interface	Description
<pre>--BMS DOD-- →1:DISABLE 2:ENABLE</pre>	<p>1. Disable BMS DOD: It will not close the discharge circuit when BMS discharging to the set SOC. 2. Enable BMS DOD: It will close the discharge circuit when BMS discharge to the set SOC . Note that don not enable BMS DOD unless there's a special reason.</p>

⑪ Maintain SOC

Interface	Description
<pre>--Maintain SOC-- 1:DISABLE →2:ENABLE</pre>	<p>1. Disable: The minimum SOC will not be maintained. 2. Enable: The minimum SOC 2% is maintained. When the battery SOC is less than 2%, the grid charges the battery pack to 5% through the inverter.</p>

⑫ FORCE WAKE

Interface	Description
<pre>--FORCE WAKE-- →1.DISABLE 2.ENABLE</pre>	<p>1. Disable: Do not force to wake up battery packs. 2. Enable: Force to wake up the battery pack immediately if the battery is not connected.</p>

4.3.3 Grid standard

Interface	Description
<pre>--GRID STD-- → 1:CHN 2:GER 3:AUS 4:ITA ... 21:CHILE 22:Local 23:60Hz</pre>	<p>Press UP/DOWN button to move corresponding options. Here are eleven countries for selection, including China, Germany, Australia, Italy, Spain and U.K.(for detail, refers to table 10.1); Press ENTER button to confirm the selection and enter restart interface ; Press ESC button to cancel the selection and return to setting interface.</p>

4.3.4 Operation parameters

Interface	Description
<pre>--RUN SETTING-- → 1:REACT POWER 2:GRID POWER 3:VOLT MAX 5:VOLT MIN 6:FREQ MAX 7:OVER VOLT 8:UNDER VOLT 9: OVER FREQ 10:UNDER FREQ 11:REACT RESP 12:VRT_ENABLE 13:POW SI RATE</pre>	<p>Press UP/DOWN button to move corresponding options; Press Enter to enter the selected menu; Press ESC button to return to setting interface.</p> <p>Options include reactive compensation mode, grid power, discharge/charge power, low/high grid power, low/high grid voltage, low/high grid frequency, VoltOverStart and FreqOverStart (see from ① to ⑭)</p>

① Reactive mode (Users generally don't need to set it)

Interface	Description
<pre>-REACT MODE- →1:POWER FACTOR 2:REACT POWER 3:QU CURVE 4:QP CURVE</pre>	<p>Press UP/DOWN button to move corresponding options; Press Enter to confirm the input and enter power factor setting interface; (select 2, press Enter to confirm input and enter reactive power interface; Select 3, 4, the corresponding mode will be selected and return to the parameter setting interface.) Press ESC button to cancel the input and return to operation parameters interface.</p>

Power factor setting

Interface	Description
<pre>-POWER FACTOR- INPUT: C1.00</pre> <hr/> <p>Value range (L1.00~C1.00)</p>	<p>Press UP/DOWN to increase or decrease the input figure; Press ENTER button to confirm or ESC button to cancel the input and return to working interface; The input value should range between L0.80 and L0.99 or C0.8 and C1.00.</p>

Reactive Power

Interface	Description
<pre>-REACT POWER- INPUT: +60%</pre> <hr/> <p>Value range (-60%~+60%)</p>	<p>Press UP/DOWN button to adjust the input figure; Press ENTER button to confirm or ESC button to cancel the input and return to working interface; The input value should range between -60% and +60%, which varies with the standard.</p>

② Grid-connected power

Interface	Description
-GRID PERCENT- INPUT: 100%	Press UP/DOWN button to adjust the input figure; Press ENTER button to confirm or ESC button to cancel the input and return to operation parameters interface; The input value should range between 0 and 100.
Value range (0~100)	

③ Volt Max

Interface	Description
-VOLT MAX - →1:INV MAX 2:GRID MAX	Enter option 1 to adjust the maximum volt of the INV. Enter option 2 to adjust the maximum volt of the grid.

High INV voltage

Interface	Description
-INV VOLT HIGH- INPUT: UNIT: V	<p>INV Over Voltage Protection Point Press UP/DOWN to adjust the input figure; Press Enter to confirm the input and enter restart interface; Press ESC to cancel the input and return to operation parameters interface; The value should range between 240V and 280V, which varies with different standards.</p>
Value range (240~280V)	

GRID VOLT MAX

Interface	Description
-GRID MAX- INPUT: 270V	<p>GRID Over Voltage Protection Point Press UP/DOWN to adjust the input figure; Press Enter to confirm the input.</p>

④ Volt Min

Interface	Description
-VOLT MIN- →1:VAC-MIN 2:GRID MIN	Enter option 1 to adjust the minimum volt of the INV. Enter option 2 to adjust the minimum volt of the grid.

Low INV voltage

Interface	Description
-INV VOLT LOW- INPUT: UNIT: V	<p>INV Low Voltage Protection Point Press UP/DOWN button to adjust the input figure; Press Enter to confirm the input and enter restart interface; Press ESC button to cancel the input and return to operation parameters interface; The value should range between 150V and 220V, which varies with different standards.</p>
Value range (150~200V)	

Grid Volt Min

Interface	Description
-GRID MIN- INPUT: 170V	<p>GRID Low Voltage Protection Point Press UP/DOWN to adjust the input figure; Press Enter to confirm the input.</p>

⑤ Freq Max

Interface	Description
-FREQ MAX- →1:INV-MAX 2:GRID MAX	Enter option 1 to adjust the maximum frequency of the INV. Enter option 2 to adjust the maximum frequency of the grid.

High INV frequency

Interface	Description
-INV FREQ HIGH- INPUT: 52.0 UNIT: Hz	INV Over Frequency Protection Point Press UP/DOWN to adjust the input number; Press ENTER to confirm the input and enter restart interface; Press ESC to cancel the input and return to operational parameters interface; The value ranges between 50.5 and 55, which varies with different standards.
Value range (50.5~55)	

GRID Freq Max

Interface	Description
-GRID MAX- INPUT: 53.5Hz	GRID Over Frequency Protection Point Press UP/DOWN to adjust the input figure; Press Enter to confirm the input.

⑥ Freq Min

Interface	Description
-FREQ MIN- →1:INV MIN 2:GRID MIN	Enter option 1 to adjust the minimum frequency of the INV. Enter option 2 to adjust the minimum frequency of the grid.

Low INV frequency

Interface	Description
-INV FREQ LOW- INPUT: UNIT: Hz	INV Low Frequency Protection Point Press UP/DOWN to adjust the input figure; Press Enter to confirm the input and enter restart interface; Press ESC to cancel the input and return to operation parameters interface; The value ranges between 45 and 49.8, which varies with different standards.
Value range (45~49.8)	

GRID Freq Min

Interface	Description
-GRID MIN- INPUT: 50.5Hz	GRID Low Frequency Protection Point Press UP/DOWN to adjust the input figure; Press Enter to confirm the input.

⑦ OVER VOLT

Interface	Description
-OVER VOLT- →1:ENABLE 2:VOLT	Enter the option 1 to enable or disable the function that the power of inverter derates when voltage is too high. Enter the option 2 to adjust the exact value of the voltage when power starts to derate.

OVER VOLT ENABLE

Interface	Description
-OVER VOLT- →1:DISABLE 2:ENABLE	Derate power when Voltage over. The default option is enable.

OVER VOLT START

Interface	Description
-OVER START- INPUT: 264V	Press UP/DOWN to adjust the input figure; Press Enter to confirm the input.

⑧ UNDER VOLT

Interface	Description
-UNDER VOLT- →1:ENABLE 2:VOLT	Enter the option 1 to enable or disable the function that the power of inverter derates when voltage is too low. Enter the option 2 to adjust the exact value of the voltage when power start to derate.

UNDER VOLT ENABLE

Interface	Description
-UNDER VOLT- →1:DISABLE 2:ENABLE	Enable or disable the function that the power of inverter derates when voltage is too low.

UNDER VOLT START

Interface	Description
-UNDER START- INPUT: 200V	Press UP/DOWN to adjust the input figure; Press Enter to confirm the input.

⑨ OVER FREQ

Interface	Description
-OVER FREQ- →1:ENABLE 2:FREQ	Enter the option 1 to enable or disable the function that the power of inverter derates when frequency is too high. Enter the option 2 to adjust the exact value of the frequency when power start to derate.

OVER FREQ ENABLE

Interface	Description
-OVER FREQ- →1:DISABLE 2:ENABLE	Derate power when Frequency over. The default option is enable.

OVER FERQ START

Interface	Description
-OVER START- INPUT: 50.50Hz	Press UP/DOWN to adjust the input figure; Press Enter to confirm the input.

⑩ UNDER FREQ

Interface	Description
-UNDER FREQ- →1:ENABLE 2:FREQ	Enter the option 1 to enable or disable the function that the power of inverter derates when frequency is too low. Enter the option 2 to adjust the exact value of the frequency when power start to derate.

UNDER FREQ ENABLE

Interface	Description
-UNDER FREQ- →1:DISABLE 2:ENABLE	Derate power when Frequency is too low. The default option is enable.

UNDER FERQ START

Interface	Description
-UNDER FERQ START- INPUT: 50.50Hz	The function that the power of inverter derates when frequency is too low. Press UP/DOWN to adjust the exact value of the frequency when power start to derate.

⑪ REACT RESP

Interface	Description
-REACT RESP- INPUT: 10s	The input value of Reactive response time. The value ranges from 6s to 60s and default value is 10s.
Value Range (6s ~ 60s)	

⑫ VRT_ENABLE

Interface	Description
-VRT_ENABLE- →1:DISABLE 2:ENABLE	Enable or disable the High/Low voltage ride through capability.

⑬ POW SI RATE

Interface	Description
-POW SI RATE- INPUT: 250%	The input value of power rising rate. Default value is 250%.

4.3.5 485 Address

Interface	Description
-485 ADDRESS- INPUT:1	Press UP/DOWN button to adjust the input figure; Press ENTER button to confirm or ESC button to cancel the input and return to setup interface; The input value should range between 1 and 32.
Value range (1~32)	

4.3.6 485 Baud rate

Interface	Description
-SELECT- 1:2400 bps 2:4800 bps →3:9600 bps	Press UP/DOWN button to move corresponding options; Press ENTER button to confirm or ESC button to cancel the selection and return to setup interface; There are three alternative options: 2400/4800/9600.

4.3.7 Language

Interface	Description
-LANGUAGE- →1:CHINESE 2:ENGLISH 3:Italia	Press UP/DOWN button to move corresponding options; Press ENTER button to confirm or ESC button to cancel the selection and return to setup interface;

4.3.8 LCD backlight

Interface	Description
-LIGHT TIME- INPUT: 20 UNIT: S (seconds)	Press UP/DOWN button to adjust the input figure; Press ENTER button to confirm or ESC button to cancel the input and return to setup interface; The input value should range between 20 and 120.
Value range (20~120)	

4.3.9 Date/time

Interface	Description
<pre>--DATE/TIME-- DATE:2020-07-19 TIME:10:01:12 WEEK:Monday</pre>	<p>Press UP/DOWN button to adjust the input figure; Press Enter button to move cursor backward, confirm input and return to setup interface; Press ESC button to move cursor forward and return to setup interface; The input value should range between 2000 and 2099.</p>

4.3.10 Clear history

Interface	Description
<pre>--DEL REC-- →1:CANCEL 2:CONFIRM</pre>	<p>Clear all the previous history in Inquiry/Record menu. Press UP/DOWN button to move corresponding options; Press ENTER button to confirm or ESC button to cancel the selection and return to setup interface;</p>

4.3.11 Password Setting

Interface	Description
<pre>--PASSWORD-- OLD: XXXXX EW: XXXXX CONFIRM: XXXXX</pre>	<p>This interface will be used to change password for entry into the setup interface; Press UP/DOWN to adjust the input figure; Press Enter to move cursor backward, confirm input and return to setup interface; Press ESC to move cursor forward and return to setup interface;</p>

4.3.12 Maintenance

Interface	Description
<pre>→12:MAINTENANCE</pre>	<p>Maintainer use only.</p>

4.3.13 Factory default setting

Interface	Description
<pre>-FACTORY RESET- →1:CANCEL 2:CONFIRM</pre>	<p>Press UP/DOWN button to move corresponding options; Press Enter to enter the selected item.</p>

4.3.14 AutoTest

Interface	Description
<pre>-- PASSWORD-- INPUT: XXXXX</pre>	<p>The Auto test function works only in the Italy grid standard. After entering the Auto test interface, the system will prompt to input password; The password is "00000".</p>

Interface	Description
<pre>Auto test . . . 603 s</pre>	<p>The self-test countdown interface. This interface will show up at the beginning of the self-test. The countdown will last for 603 seconds. You can press the ESC Key to exit the self-test.</p>

Interface	Description
<pre>--TEST LIST-- 1:VOLT MAX →2:VOLT MIN 3:FREQ MAX 4:FREQ MIN</pre>	<p>After the countdown there is a test list interface which is used to select the parameter for Autotest. There are four kinds of test results including Volt Max ,Volt Min ,Freq Max and Freq Min. After entering the submenu items, you can press the UP and Down key to scan the result.</p>

Interface	Description
VACMAX(S1) Set:253.0V 603s Tes:253.0V 603s Cur:230.0V Pass!	<ul style="list-style-type: none"> • Threshold setting value: The value set by upper computer software. • Threshold setting trip time: The trip time set by upper computer software. • Threshold auto test value: The value of threshold during coincidence between the threshold and current measured value. • Threshold auto test trip time: The time from the coincidence between the threshold and current to the trip signal of disconnection switch. • Current measured voltage or frequency value: The measurement value of grid voltage or frequency during the coincidence.
VACMAX(S2) Set:264.0V 190ms Tes:264.0V 188ms Cur:230.0V Pass!	

Interface	Description
VACMIN Set:195.0V 1.52s Tes:195.0V 1.50s Cur:230.0V Pass!	<ul style="list-style-type: none"> • Threshold setting value: The value set by upper computer software. • Threshold setting trip time: The trip time set by upper computer software. • Threshold auto test value: The value of threshold during coincidence between the threshold and current measured value. • Threshold auto test trip time: The time from the coincidence between the threshold and current to the trip signal of disconnection switch. • Current measured voltage or frequency value: The measurement value of grid voltage or frequency during the coincidence.

Interface	Description
FACMAX(S1) Set:50.2Hz 100ms Tes:50.2Hz 94ms Cur:49.9Hz Pass!	<ul style="list-style-type: none"> • Threshold setting value: The value set by upper computer software. • Threshold setting trip time: The trip time set by upper computer software. • Threshold auto test value: The value of threshold during coincidence between the threshold and current measured value. • Threshold auto test trip time: The time from the coincidence between the threshold and current to the trip signal of disconnection switch. • Current measured voltage or frequency value: The measurement value of grid voltage or frequency during the coincidence.
FACMAX(S2) Set:51.5Hz 100ms Tes:51.5Hz 94ms Cur:49.9Hz Pass!	

Interface	Description
FACMIN(S1) Set:49.8Hz 100ms Tes:49.8Hz 97ms Cur:49.9Hz Pass!	<ul style="list-style-type: none"> • Threshold setting value: The value set by upper computer software. • Threshold setting trip time: The trip time set by upper computer software. • Threshold auto test value: The value of threshold during coincidence between the threshold and current measured value. • Threshold auto test trip time: The time from the coincidence between the threshold and current to the trip signal of disconnection switch. • Current measured voltage or frequency value: The measurement value of grid voltage or frequency during the coincidence.
FACMIN(S2) Set:47.5Hz 100ms Tes:47.5Hz 94ms Cur:49.9Hz Pass!	

4.4 Inquiry

Interface	Description
--INQUIRE-- →1:INV MODULE 2:MODULE SN 3:FIRMWARE 4:RECORD 5:BMS INFO	Press UP/DOWN button to move corresponding options; Press Enter button to jump to the selected menu; Press ESC button to return to user interface; There are four alternative options: machine model , serial number , firmware version and running records (refer to 1 to 5).

① Machine model

Interface	Description
--INVERTER-- H3-5	This interface displays machine model of the inverter; Press ESC button to return to inquiry interface.

② Serial number

Interface	Description
-SERIAL NUMBER- SN: 123456789532625	This interface displays serial number of the inverter; Press ESC button to return to inquiry interface.

③ Firmware Version

Interface	Description
<pre>--FIRMWARE-- ARM VER:1.0.0 DSP VER:1.0.0</pre>	This interface displays firmware version for ARM and DSP of the inverter; Press ESC button to return to inquiry interface.

④ Running records

Interface	Description
<pre>--REC(170)-- 1:F10-1 DATE: 2018-12-01 TIME: 00:01-02</pre>	SN of the fault: Fault warning codes (500 at utmost)(the latest fault or alarm marked as No.1) Time of the fault: Press UP/DOWN button to view the record; Press ENTER button to enter the description interface for corresponding records; Press ESC button to return to Inquiry interface.

⑤ BMS INFO

Interface	Description
<pre>--PACK INFO-- →1:PACK 1 2:PACK 2 3:PACK 3 4:PACK 4 5:PACK 5</pre>	You can query the following information about the five battery packs: BMS program version, Whether the battery pack is online, Number of battery pack cycles, Heating film state, heating film open or closed, Charging MOS tube status: charging MOS off or on, Discharge MOS tube status: discharge MOS off or on, Battery pack BMS alarm code, Battery pack BMS protection code, BMS fault code of the battery pack.
<pre>VERSION: 1.012 STATUS: ONLINE CYCLE CNT: 15 HEAT FILM: OFF CHAR MOSFET: OFF DISC MOSFET: OFF WARN CODE: 12 PROTECT: 32 FAULT CODE: 14</pre>	

4.5 Statistics

Interface	Description
<pre>--STAT-- →1:TIME STAT. 2:CONNE. TIMES 3:PEAK POWER 4:E-TODAY 5:E-MONTH 6:E-TEAR 7:E-TOTAL</pre>	Press UP/DOWN button to move corresponding options; Press Enter to enter the selected menu; Press ESC button to return to user interface; There are eight alternative options in total: time accounting , grid-connection frequency/ peak power/ power generation for the day / power generation for the month/ power generation for the year/gross power generation (refer to 1 to8).

① Time accounting

Interface	Description
<pre>-Time- RUN: 5 GRID: 0 UNIT: HOUR</pre>	Operation length of inverter (hours) Grid-connection length (hours) Press ESC button to return to statistics interface.

② Grid-connection frequency

Interface	Description
<pre>-- CONNE.TIMES -- TIMES: 0</pre>	This interface displays grid-connection frequency of the inverter ; Press ESC button to return to statistics interface.

③ Peak power

Interface	Description
<pre>--PEAK POWER-- HISTORY: 5000 TODAY: 0 UNIT: W</pre>	This interface displays power peak in history and for the day. Press ESC button to return to statistics interface.

④ The day

Interface	Description
<pre>--E-TODAY-- PV: 0.0KWH METER: 0.0KWH GRID: 0.0KWH LOAD: 0.0KWH CHARG: 0.0KWH DISCH: 0.0KWH</pre>	This interface displays power generation for the day (kWh) ; PV power generation; Electric energy selling to grid; Electric energy buying from grid; Power consumption of load;

⑤ The month

Interface	Description
<pre>--E-MONTH-- PV: 0.0KWH METER: 0.0KWH GRID: 0.0KWH LOAD: 0.0KWH</pre>	This interface displays power generation for the month (kWh) ; PV power generation; Electric energy selling to grid; Electric energy buying from grid; Power consumption of load;

⑥ The year

Interface	Description
<pre>--E-YEAR-- PV: 0.0KWH METER: 0.0KWH GRID: 0.0KWH LOAD: 0.0KWH</pre>	This interface displays power generation for the year (kWh) ; PV power generation; Electric energy selling to grid; Electric energy buying from grid; Power consumption of load;

⑦ Gross generation

Interface	Description
<pre>--E-TOTAL- PV: 0.0KWH METER: 0.0KWH GRID: 0.0KWH LOAD: 0.0KWH CHARG: 0.0KWH DISCH: 0.0KWH</pre>	This interface displays gross power generation; PV power generation; Electric energy selling to grid; Electric energy buying from grid; Power consumption of load;

4.6 Restart

Interface	Description
<pre>Please Restart!</pre>	

05 Battery Storage and Recharging

5.1 Battery storage requirements

- Storage environment requirements:
 - ambient temperature: -10°C–45°C; recommended storage temperature: 20°C–30°C;
 - relative humidity: 0%RH–90%RH;
 - in a dry, ventilated and clean place;
 - no contact with corrosive organic solvents, gases and other substances;
 - no direct sunlight;
 - less than 2 meters from any heat source.

5.2 Storage expirations

In principle, it is not recommended to store the battery for a long time. Be sure to use it in time. The stored batteries should be disposed according to the following requirements.

Table 5.2 Stored lithium battery recharging interval

Required Storage Temperature	Actual Storage Temperature	Recharging Cycle
-10°C ~ +45°C	-10°C ≤ T ≤ 30°C	12 months
	30°C < T ≤ 45°C	8 months

- If a battery is deformed, broken or leaking, discard it immediately regardless of its storage time.
- The allowable maximum stored battery recharging period is 3 years and the allowable maximum stored battery recharging times is 3. For example, if recharging is performed once every 8 months, the allowable maximum recharging times is 3 times; if recharging is performed once every 12 months, the allowable maximum recharging times is 3 times; if the allowable maximum stored battery recharging period or times is exceeded, it is recommended to discard the battery.
- A lithium battery will have its capacity decreasing after being stored for a long time, and typically will have its capacity irreversibly decreasing by 3%–10% after being stored at the recommended storage temperature for 12 months. If the customer conducts the discharge test and acceptance according to the specification, there is a risk that the battery with a capacity less than 100% after being stored will fail the test.

5.3 Inspection before battery recharging

Before recharging a battery, check its appearance: Deformation/Shell damage/Leakage

5.4 Recharge Operation Steps

Step 1: Connect power cables to the battery charger correctly. The maximum number of battery PACK connected parallel is 5.

Step 2: Turn on the battery PACK DC breaker to ON; Press the battery "start key" for 3 second to start the battery PACK. Check the LED on the battery PACK is on.

Step 3: Turn on the battery charger.

Step 4: Set charging parameter on the battery charger.

Case #1, One battery PACK is charged. Set the charge limited voltage 56.5V; Set the charge limited current 50A;

Case #2, Two ~ Five battery PACKs are charged. Set the charge limited voltage 56.5V; Set the charge limited current 100A;

Step 5 After the battery is charged, switch off the battery charger and then the battery DC breaker. Disconnect the DC cables and then press the battery "start key" for 3 second to switch off the battery PACK.

06 Stick Logger Quick Guide

6.1 Download APP

Step 1: Scan the QR Code on the right side and download the APP.

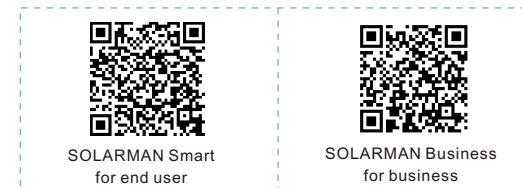

IPhone: Search "SOLARMAN Smart" in Apple Store.
Android: Search "SOLARMAN Smart" in Google Play.

6.2 Stick Logger Installation

Step 1: Assemble logger to the inverter communication interface as shown in the diagram.

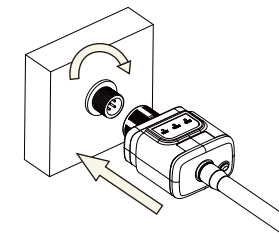

Warning

Please do not hold the logger body to rotate while install or remove the logger.



6.3 Logger Status

6.3.1 Check Indicator light

Lights	Implication	Status Description(All lights are single green lights.)
	Communicate with router	1.Light off: Fail to connect to the router. 2.On 1s/Off 1s(Slow flash): Successful connection to the router. 3.Light keeps on: Successful connection to the server. 4.On 100ms/Off 100ms(Fast flash): Distributing network fast.
	Communicate with inverter	1.Light keeps on: Logger connected to the inverter. 2.Light off: Fail to connect to the inverter. 3.On 1s/Off 1s(Slow flash): Communicating with inverter.
	Logger running status	1.Light off: Running abnormally. 2.On 1s/Off 1s (Slow flash): Running normally. On 100ms/Off 100ms(Fast flash): Restore factory settings.

The normal operation status of the stick logger, when router connected to the network normally:

- 1.Successful connection status with serve: NET light keeps on after the logger powered on.
- 2.Logger running normally: READY light flashes.
- 3.Successful connection status with inverter : COM light keeps on.

6.4 Abnormal State Processing

If the data on platform is abnormal when the stick logger is running, please check the table below and according to the status of indicator lights to complete a simple troubleshooting. If it still can not be resol-ved or indicator lights status do not show in the table below, please contact our Customer Service..(Note: Please using the following table query after power-on for 2mins at least.)

NET 	COM 	READY 	Fault Description	Fault Cause	Solution
Any state	OFF	Slow flash	Communicate with inverter abnormally	1.Connection between stick logger and inverter loosen. Inverter does not match with stick logger's communication rate.	1.Check the connection between stick logger and inverter. Remove the stick logger and install again. 2.Check inverter's communication rate to see if it matches with stick logger's. 3.Long press Reset button for 5s, reboot stick logger.
OFF	ON	Slow flash	Connection between logger and router abnormal	1.Stick logger does not have a network. 2.Antenna abnormal 3.Router WiFi signal strength weak.	1.Check if the wireless network configured. 2.Check the antenna, if there is any damage or loose. 3.Enhance router WiFi signal strength. Long press Resetbutton for 10s, reboot stick logger and networking again.
Slow flash	ON	Slow flash	Connection between logger and router normal, connection between logger and remote server abnormal.	1.Router networking abnormal. 2.The server point of logger is modified. 3.Network limitation, server cannot be connected.	1.Check if the router has access to the network. 2.Check the router's setting, if the connection is limited.
OFF	OFF	OFF	Power supply abnormal	1.Connection between stick logger and inverter loosen or abnormal. 2.Inverter power insufficient. 3.Stick Logger abnormal.	1.Connection between logger and router normal, connection between logger and remote server abnormal.
Fast flash	Any state	Any state	SMARTLINK networking status	Normal	1.Exit automatically after 5mins. 2.Long press Reset button for 5s, reboot stick logger. 3.Long press Reset button for 10s, restore factory settings.
Any state	Any state	Fast flash	Restore factory settings	Normal	1.Exit automatically after 1mins. 2.Long press Reset button for 5s, reboot stick logger. 3.Long press Reset button for 10s, restore factory settings.

6.5 Usage Methods and Notices for Reset Button

6.5.1 Usage methods and key-press descriptions for reset button

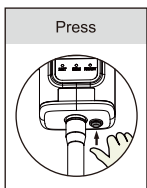

Key-press	Status Description	Light Status
Short press 1s	SMARTLINK rapid networking status.	NET light flashes fast for 100ms.
Long press 5s	Rebooting the stick logger.	All lights are extinguished immediately.
Long press 10s	Resetting the stick logger.	1.All lights are extinguished after 4s. 2.READY light flashes fast for 100ms.

6.5.2 Notice



Notice

Do not remove waterproof plug.



07 SOLARMAN Smart APP

7.1 Registration

Go to SOLARMAN Smart and register. Click "Register" and create your account here.

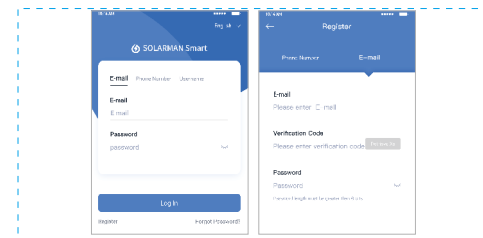

7.2 Create a Plant

Click "Add Now" to create your plant. Please fill in plant basic info and other info here.

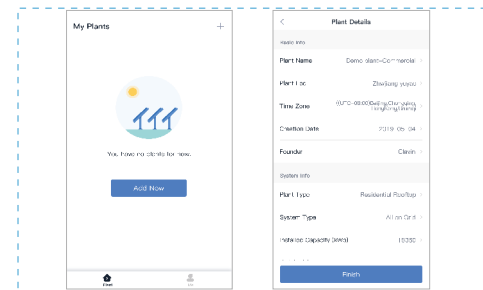

7.3 Add a Logger

Method 1: Enter logger SN manually. Method 2: Click the icon in the right and scan to enter logger SN You can find logger SN in the external packaging or on the logger body.

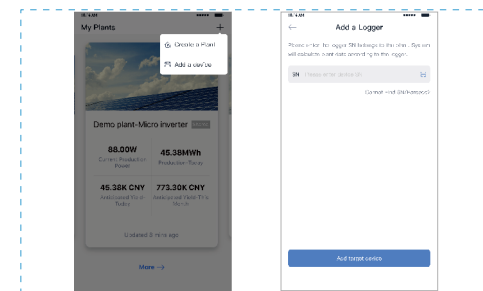

7.4 Network Configuration

After the logger is added, please configure the network to ensure normal operation. Go to "Plant Details"->"Device List", find the target SN and click "Networking".

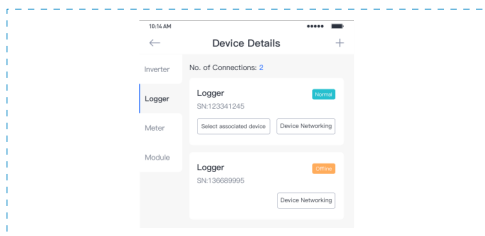

Step 1 : Confirm Wi-Fi Info

Please make sure your phone has connected to the right WiFi network. And click "Start".

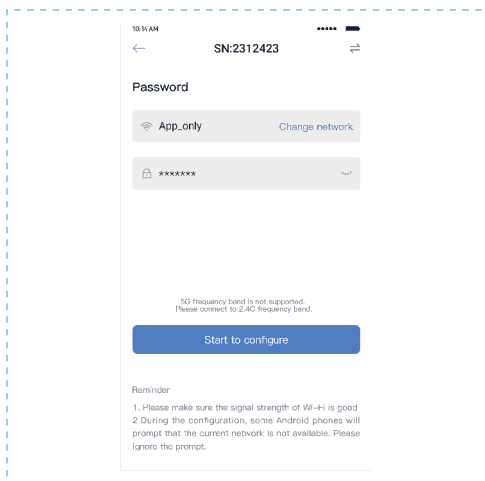

Notice

5G WiFi is not supported .
Special characters (e.g. , ; " = " `) in router name and password are not supported.

Step 2 : Connect to AP network

Click "Go to connect" and find the right "AP_XXXXX" network (XXXXX refers to logger SN). If the password is required, you can find the password on the logger body. Go back to SOLARMAN Smart APP, after connecting to AP network.

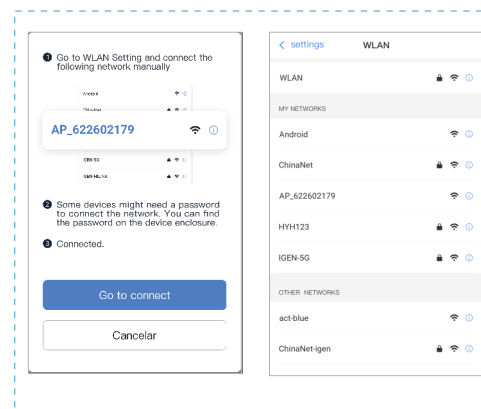

Step 3 : Auto Configuration

Please wait for a while to complete the configuration. Then system will switch to the following page. Click "Done" to check plant data. (Usually, the data will be updated in 10 mins)

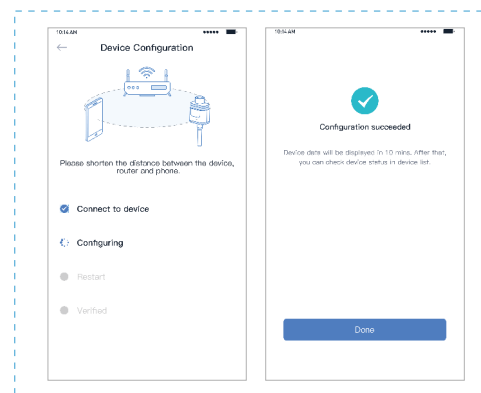

If configuration failure occurs, please check the following reason and try it again.

- (1) Make sure WLAN is ON.
- (2) Make sure WiFi is normal.
- (3) Make sure wireless router does not implement the white-black list.
- (4) Remove the special characters in Wi-Fi network.
- (5) Shorten the distance between the phone and device.
- (6) Try to connect to other Wi-Fi.

08 Alarm Code And Error Code

8.1 Alarm code

Codes	English description
W00	Grid Volt Low
W01	Grid Volt High
W02	Grid Frequency Low
W03	Grid Frequency High
W04	Solar Loss
W05	Bat Loss
W06	Bat Under Volt
W07	Bat Volt Low
W08	Bat Volt High
W09	Over Load
W10	GFCI Over
W11	LN Reverse
W12	Fan Fault
W13	BAT Power Down
W14	BMS Discharge Over Current
W15	BMS charge Over Current
W16	BMS Over Volt
W17	BMS Over Temp
W18	BMS Discharge Low Temp
W19	Bms Volt Imbalance
W20	Bms Communicate Fault
W21	BMS Under Volt
W22	Bms Chg Temp Low
W23	BMS Severe Over Volt
W24	BMS Severe Over Temp
W25	CT Reverse

8.2 Error code

Codes	English description
F00	Soft Time Out
F01	INV Volt Short
F02	GFCI Sensor Fault
F04	Bus Volt Low
F05	Bus Volt High
F06	Bus Short Circuit
F07	PV ISO Under Fault
F08	PV Input Short Circuit
F09	Bypass Relay Fault
F10	INV Curr Over
F11	INV DC Over
F12	Ambient Over Temp
F13	Sink Over Temp
F14	Grid Relay Fault
F15	DisChg Curr Over
F16	Chg Curr Over
F17	Current Sensor Fault
F18	INV Abnormal
F19	EPS Relay Fault
F20	Alway Over Load
F32	SCI Fault

09 Fault Diagnosis And Solutions

The inverter is easy to maintain. When you encounter the following problems, please refer to the Solutions below, and contact the local distributor if the problem remains unsolved. The following table lists some of the basic problems that may occur during the actual operation as well as their corresponding basic solutions.

Fault diagnosis table

Types	Codes	Solutions
Soft Time Out	F00	(1) Restart the inverter and wait until it functions normally; (2) Contact customer service if error warning continues.
INV Volt Short	F01	(1) Cut off all the power and shut down all the machines; disconnect the load and plug in to restart machines, then check whether the load is short circuited if the fault has been eliminated; (2) Contact customer service if fault remains unremoved.
GFCI Sensor Fault	F02	(1) Cut off all the power, Restart the inverter and wait until it functions normally. (2) Contact customer service if error warning continues.
Bus Volt Low	F04 F05	(1) Check the input mode setting is correct. (2) Restart the inverter and wait until it functions normally. (3) Contact customer service if error warning continues.
Bus Volt Short	F06	(1) Restart the inverter and wait until it functions normally. (2) Contact customer service if error warning continues.
PV ISO Under Fault	F07	(1) Check for good ground connection.; (2) Check if the earth resistance of PV+ and PV- is greater than 2MΩ; (3) If it is smaller than 2MΩ, check PV string for ground fault or poor ground insulation; if it is greater than 2MΩ, please contact the local inverter customer service once fault is not removed.

Types	Codes	Solutions
PV Input Short Circuit	F08	(1) Check the input mode setting is correct. (2) Disconnect the PV input, restart the inverter and wait until it functions normally. (3) Contact customer service if error warning continues.
Relay Fault	F09 F14 F19	(1) Disconnect the PV input, restart the inverter and wait until it functions normally. (2) Contact customer service if error warning continues.
INV Current Over	F10	(1) Wait five minutes for the inverter to automatically restart; (2) Check whether the load is in compliance with the specification; (3) Contact customer service if error warning continues.
INV DC Over	F11	(1) Restart the inverter and wait until it functions normally. (2) Contact customer service if error warning continues.
NTC/Sink Temp Over	F12 F13	(1) Restart the inverter, restart the machine after a few minutes of cooling, and observe whether the machine can return to normal. (2) Check if the ambient temperature is outside the normal operating temperature range of the machine. (3) Contact customer service if error warning continues.
Dischg Curr Over	F15	(1) Wait one minute for the inverter to restart; (2) Check whether the load is in compliance with the specification; (3) Contact customer service if error warning continues.
CHG Current Over	F16	(1) Check if battery wiring port is short circuited; (2) Check if charging current is in compliance with presetting; (3) Contact customer service if error warning continues.
Current Sensor Fault	F17	(1) Restart the inverter and wait until it functions normally. (2) Contact customer service if error warning continues.

Types	Codes	Solutions
INV Abnormal	F18	(1) Please contact the distributor.
Communication Fault	F32	(1) Restart the inverter and wait until it functions normally. (2) Contact customer service if error warning continues.
Grid Fault	W00 W01 W02 W03	(1) Check if the local voltage and frequency is in compliance with the machine specification; (2) If voltage and frequency are within the accepted range, then wait 2 minutes for the inverter to function normally; but if no recovery or fault repeats, please contact the local inverter customer service; (3) Contact the local power company if voltage and frequency are beyond range or unstable.
Solar Loss	W04	(1) PV is not connected; (2) Check grid connection; (3) Check PV availability.
Bat Loss	W05	(1) Battery is not connected; (2) Check if battery wiring port is short circuited; (3) Contact customer service if error warning continues.
Bat Volt Low	W06 W07	(1) Check the battery availability; (2) Contact customer service if error warning continues.
Bat Volt High	W08	(1) Check if the battery is in line with the presetting; (2) If so, power off and restart; (3) Contact customer service if error warning continues.
Over Load Warning	W09	(1) Wait one minute for the inverter to restart; (2) Check whether the load is in compliance with the specification;
CFCI Over	W10	(1) Check PV string for direct or indirect grounding phenomenon; (2) Check peripherals of machine for current leakage; (3) Contact the local inverter customer service if fault remains unremoved.

LN Reverse	W11	(1) Check whether the installation follows the instructions; (2) Contact customer service if error warning continues.
Fan Fault	W12	(1) Restart the inverter and wait until it functions normally. (2) Contact customer service if error warning continues.
BMS Fault	W14~W25	(1) Please contact the distributor.

10 Product Specifications

Battery Specifications	BluE-PACK5.1	BluE-PACK10.2
Electrical		
Energy Capacity	5.12kWh	10.24kWh
Battery Type	LFP (LiFePO4)	
Depth of Discharge (DoD)	90%	
Rated Voltage	51.2V	
Operating Voltage Range	44.8~56.5Vdc	
Operation		
Maximum Charging Current	50A (0.5C)	100A (0.5C)
Maximum Discharging Current	80A (0.8C)	100A (0.5C)
Operating Temperature Range	0°C~+50°C(Charging)/-10°C ~ +50°C(DisCharging)	
Storage Temperature Range	-20°C ~ +50°C	
Humidity	0% ~ 90%	
BMS		
Modules Connection	Max. 4 batteries in parallel	
Monitoring Parameters	System voltage, current, cell voltage, cell temperature, PCBA temperature measurement	
Communication	CAN and RS-485 compatible	
Ventilation Type	Passive and Active Cooling	

Physical		
Weight (Kg)	58	116
Dimension (W×H×D)mm	540*530*240	540*1020*240
IP Protection	IP65	
Warranty	5 Year Product Warranty, 10 Year Performance Warranty	

Certificate	
Safety(Cell)	IEC 62619, UL 1973, UN 38.3

MODEL	BluE-S 3680D-M1	BluE-S 5000D-M1	BluE-S 6000D-M1
-------	-----------------	-----------------	-----------------

PV terminal			
Vmax. PV	580Vd.c.		
Rated Voltage	400Vd.c.		
MPPT Voltage Range	80~560Vd.c.		
MPPT Range (full load)	165~520Vd.c.	210~520Vd.c.	250~520Vd.c.
MPPT Tracker / Strings	2		
Max. Continuous PV Input Current	15Ad.c.×2		
Isc PV	18Ad.c.×2		
Max. Backfeed Current	0Ad.c.		
Max. Continuous PV Input Power	4800W	6500W	7500W

Battery terminal		
Battery Type	Lithium or lead-acid batteries	
Voltage Range	40~60Vd.c.	
Rated Voltage	48Vd.c.	
Maximum Charge/Discharge Current	50Ad.c./80Ad.c.	100Ad.c./100Ad.c.
Maximum Charge/Discharge Power	3000W/4000W	4600W/5000W

Grid terminal parameter	
Rated Voltage	230Va.c.
Rated Frequency	50Hz/60Hz

Maximum Continuous Input Current	32Aa.c.		
Maximum Continuous Input Power	7360VA		
Maximum Continuous Output Current	16Aa.c.	22Aa.c.	25Aa.c.
Power Factor (Cos phi), Adjustable	0.8 leading ~ 0.8 lagging (0.95 leading ~ 0.95 lagging for Germany)		
Maximum Continuous Output Power	3680W	5000W	6000W
Max. Output Fault Current	102Apeak		
Grid Port Inrush Current	Less than 22Apeak		
Grid Port Overcurrent Protection	40A		

Backup load terminal parameter		
Rated Voltage	230Va.c.	
Rated Frequency	50Hz	
Maximum Continuous Output Current	16Aa.c.	20Aa.c.
Rated Frequency	50/60Hz (Fluctuation range±0.2%)	
Rated Continuous Output Power	3680W	4600W
Maximum Output Apparent Power	4000VA	5000VA
Max. Output Fault Current	99Apeak	
Backup Load Overcurrent Protection	32A	

General parameter	
Temperature	-25°C to +60°C, derating above 45 °C
Protective Class	Class I
Overvoltage Category	II(DC side), III(AC side)
Ingress Protection	IP65
Altitude	≤ 2000m
Dimension (W×H×D)mm	540*590*240
Weight (Kg)	32
Relative Humidity	0~95% (No condensation)

Topology	High Frequency Isolation
Cooling	Natural Convection
Display	LCD/APP
Communication Interface	RS485/CAN2.0/WIFI
Max. Conversion Efficiency (From Battery)	94.0%
Max. Conversion Efficiency (From PV)	97.6%
Euro Efficiency	97.0%
MPPT Efficiency	99.5%
Protection Function	Short Circuit Protection, AC Leakage Fault Protection, Grounding Fault Protection, Anti-islanding Protection, Overload Protection, Surge Protection, DC Polarity Protection
Certification& Standard	
Grid Regulation	AS/NZS 4777.2, VDE-AR-N4105, VDE0126-1-1
Safety Regulation	IEC/EN 62109-1&2, IEC62040-1
EMC	EN61000-6-1, EN61000-6-2, EN61000-6-3, EN61000-6-4, EN61000-4-16, EN61000-4-18, EN61000-4-29

Table 10.1 Grid specification (single-phase)

Grid Specification	Output Voltage Range (Vac)	Output Frequency Range (Hz)	Boot wait time(S)
China	187~252	48~50.5	30
Germany	184~264	47.5~51.5	60
Australia	180~260	47~52	60
Italy	184~276	49.7~50.3	60
Spain	196~253	48~50.5	180
U.K.	184~264	47~52	180
Hungary	196~253	49~51	300
Belgium	184~264	47.5~51.5	60
W-Australia	180~260	45~52	60
Greece	184~264	49.5~50.5	180
France	184~64	47.5~50.4	60
Bangkok	150~264	49~51	150
Thailand	150~264	48~51	60
S.Africa	184~264	47.0~52.0	60
50549	196~253	47.5~51.5	60
Brazil	196~253	57.5~61.5	60
0126	184~253	47.5~51.5	60
Ireland	184~264	47.5~52.0	180
Israel	195.5~253.0	47.0~51.5	60
Poland	195.5~253.0	49.00~50.05	60
Chile	176.0~242.0	47.5~51.5	60
Local	150~280	45.0~55.0	30
60Hz	184~264	59.5~60.5	60

11 Routine Maintenance

11.1 Maintenance Plan

- ◆ Check if wire connections are loose.
- ◆ Check if cables are aged/damaged.
- ◆ Check if cable insulating ribbon drops.
- ◆ Check if cable terminal is loose, any overheat sign.
- ◆ Check if ground connection is good.

11.1.1 Operating Environment

(Every six months)

Carefully observe whether the battery system equipment is ineffective or damaged; When the system is running, listen to any part of the system for abnormal noise; Check whether the voltage, temperature and other parameters of the battery and other equipment parameters are normal during system operation;

11.1.2 Equipment Cleaning

(Every six months to one year, depending on the site environment and dust content, etc.) Ensure that the ground is clean and tidy, keep the maintenance access route unblocked, and ensure that the warning and guiding signs are clear and intact. Monitor the temperature of the battery module and clean the battery module if necessary.

11.1.3 Cable, Terminal and Equipment Inspection

(Every six months to one year)

- ◆ Check if the cable connections are loose.
- ◆ Check whether the cables are aged / damaged.
- ◆ Check whether the cable tie of the cable has fallen off.
- ◆ Check if the cable terminal screws are loose and the terminal position has any signs of over heating.
- ◆ Check whether the management system of the system equipment, monitoring system and other related equipment are invalid or damaged.
- ◆ Check that the grounding of the equipment is good and the grounding resistance is less than 10 ohms.

11.2 Notes

After the equipment is out of operation, please pay attention to following notes while maintaining :

- ◆ Related safety standards and specifications should be followed in operation and maintenance.
- ◆ Disconnect all the electrical connections so that the equipment would not be powered on.
- ◆ Wait at least 5 minutes after disconnection, so that the residual voltage of the capacitors drops to a safe voltage. Use a multimeter to make sure that the equipment is completely discharged.
- ◆ The equipment should be repaired by professional staff only and it is strictly forbidden for maintenance staff to open equipment modules on their own.
- ◆ Appropriate protective measures should be taken while maintaining, such as insulated gloves, shoes, and anti-noise ear plugs.
- ◆ Life is priceless. Make sure no one would get hurt first.
- ◆ In case of a deep discharge, the battery must be charged to a SOC rate of 30% to 50% if the entire system is static (the battery has not been charged for two weeks or more).

Please contact us in time if there are any conditions that could not be explained in the manual.

12 Quality Assurance

When product faults occur during the warranty period, KSTAR or his partner will provide free service or replace the product with a new one.

Evidence

During the warranty period, the customer shall provide the product purchase invoice and date. In addition, the trademark on the product shall be undamaged and legible. Otherwise, KSTAR has the right to refuse to honor the quality guarantee.

Conditions

- After replacement, unqualified products shall be processed by KSTAR.
- The customer shall give KSTAR or his partner a reasonable period to repair the faulty device.

Exclusion of Liability

In the following circumstances, KSTAR has the right to refuse to honor the quality guarantee:

- The free warranty period for the whole machine/components has expired.
- The device is damaged during transport.
- The device is incorrectly installed, refitted, or used.
- The device operates in harsh environment, as described in this manual.
- The fault or damage is caused by installation, repairs, modification, or disassembly performed by a service provider or personnel not from KSTAR or his authorized partner.
- The fault or damage is caused by the use of non-standard or non-KSTAR.

components or software.

- The installation and use range are beyond stipulations of relevant international standards.
- The damage is caused by unexpected natural factors.

For faulty products in any of above cases, if the customer requests maintenance, paid maintenance service may be provided based on the judgment of KSTAR.

13 Contact Information

18 overseas branch offices



☎ PV inverter industry Pre-sales : (86)0755-89741234 Ext 8151

☎ PV inverter industry After-sales : (86)0755-89741234 Ext 8729

✉ Global overseas service mailbox : overseas_service@kstar.com.cn