



Manual - EV Charging Station NS

Table of Contents

1. Safety Instructions	1
2. Description and features	2
2.1. Description	2
2.2. Features	2
2.3. What's in the box?	4
3. Installation	5
4. System example	6
5. Setup	7
5.1. First setup	7
5.1.1. First setup via WiFi access point	7
5.1.2. First setup via VictronConnect	10
5.2. EV Charging Station setup	13
5.3. The main page	16
5.3.1. Charging mode switch in detail	16
5.4. Networks menu	17
6. GX device setup, configuration and operation	18
6.1. Modbus TCP activation	18
6.2. Setup menu and options	18
6.3. Overview and device menu	19
7. VictronConnect setup, configuration and operation	20
7.1. Setup	20
7.2. Overview page	20
7.3. Settings page	21
7.4. Product info page	21
7.5. Reset to defaults	21
8. Reset to factory defaults and password recovery	22
9. Troubleshooting	23
9.1. CP Line Calibration	23
9.2. Frequently asked questions	23
9.2.1. Q1: How do I prevent the charging station from being used by unauthorised persons?	23
9.2.2. Q2: Does the EV Charging Station have RFID?	24
9.2.3. Q3: The light ring is annoying my neighbours during night, how can I disable the light ring?	24
9.2.4. Q4: Why isn't my car recognized when I connect the charging cable?	24
9.2.5. Q5: Why does my EV Charging Station show up on multiple GX devices?	24
9.2.6. Q6: How much PV power do I need at least to charge the EV in automatic mode?	24
9.2.7. Q7: Is it possible to operate multiple EV Charging Stations in one system?	24
9.2.8. Q8: The EV is fully charged, but the EVCS still alternates between start charging and stop charging, why?	24
9.2.9. Q9: I keep getting a GX device communication error! The minimum SoC cannot be checked. What is the reason for this?	24
9.2.10. Q10: Is a GX device in the system absolutely necessary?	24
9.2.11. Q11: I would like to control the EVCS via Modbus TCP. Is this possible and if so, how?	24
10. Maintenance	26
11. Technical specification	27
12. Appendix	28
12.1. Dimensions	28
12.2. Drilling template	29

1. Safety Instructions

Please read the safety instructions below before using the EV Charging Station NS to avoid risks of fire, electric shocks, personal injuries or equipment damage.

Installation and adjustments must be made by qualified personnel only. To reduce the risk of electric shock, do not perform any servicing other than that specified in the operating instructions unless you are qualified to do so.

For electrical work, follow the local national wiring standard, regulation and these installation instructions. Connection to the mains supply must be in accordance with the national regulations for electrical installations.

This product is designed and tested in accordance with international standards. The equipment should be used for its designated application only and in accordance with the specified operating parameters.

Warnings and cautions:



- Never install near fire sources, explosive materials, combustibles or other flammable sources. Never use it at places where gas or other chemical explosions could occur.
- It must be connected all the times to the ground, otherwise it will not allow charging.
- Turn off the EV Charging Station NS power before installing or performing operations to it.
- Make sure children are supervised if using the equipment.
- Do not put fingers or insert objects or sharp metallic objects into the terminals. Do not insert objects into any other parts of the EV Charging Station NS.
- Do not use the device if the power cord or EV cable is broken, shows any signs of damage or does not function properly.
- Do not use the EV Charging Station NS if it is broken, defective, cracked, damaged or does not function properly.
- Do not apply strong force on the equipment, to prevent crashes and deterioration.
- Do not use any sharp objects to damage the product.
- Do not service the equipment by yourself, do not open, disassemble or make any modifications to it. Contact your Victron Energy Distributor.
- Do not touch any live electrical parts.
- Do not place the EV cables connected to the charging station in water.
- Make sure ground connection is properly done to prevent equipment damage.
- Transport the device with care in its original package to avoid damage to it and its components.
- Store in a dry environment, at temperatures between $-20\text{ }^{\circ}\text{C}$ to $60\text{ }^{\circ}\text{C}$.
- Do not operate at temperatures outside the operating range of $-25\text{ }^{\circ}\text{C}$ to $50\text{ }^{\circ}\text{C}$.
- As the EV Charging Station NS can affect the functioning of certain medical electronic implants, check any potential side effects with your electronic device manufacturer before using the device.

2. Description and features

2.1. Description

The EV Charging Station NS with its three-phase and single-phase charging capabilities integrates seamlessly into the Victron environment with its [GX device](#) connection via WiFi and enables easy operation and control via Bluetooth and the [VictronConnect App](#). It delivers a maximum of 22kW AC in three-phase or 7.3kW in single-phase mode.

Not only does this EV charging station fully integrate with a Victron Energy GX device and VRM, if you have solar, it can also be set up to allow excess energy from the sun to directly charge your vehicle once certain parameters are met. See the [EV Charging Station Setup \[13\]](#) chapter for details.

The tough plastic enclosure is designed to withstand harsh weather and can be mounted inside or outside. In addition to the default blue device front, a black and a white front are also available.

A programmable RGB light ring around the charging port (type 2 EV charging plug) allows for quick determination of the device state and can be programmed from the integrated web interface to display different light effects based on the current state (disconnected, charging, charged etc.).

2.2. Features

Three operation modes:

1. Automatic mode to ensure maximum PV system efficiency

Thanks to the seamless integration of the EV Charging Station NS with the rest of the Victron installation, it detects when surplus power is available and uses only this power to charge the vehicle. Note that this mode requires a GX device in your system and communication between GX device and EVCS enabled. For details, see chapter [EV Charging Station setup \[13\]](#).

Instead of losing surplus energy when the batteries are full and, for example, feeding it back into the grid at a lower price, the energy is stored into the EV battery.

- Seamless integration into the Victron installation
- Detects when excess power is available and uses only that to charge the vehicle before exporting it to the grid
- Ensures maximum PV efficiency
- Battery-powered algorithm (used by default) for automatic mode ensures that automatic mode works even when off-grid

How does it work?

The EVCS will automatically start charging when the vehicle is connected and the following conditions are met:

1. The current state of charge is above the 'Start charging at backup battery SoC (%) value.
2. There is enough excess solar power available, with excess solar power calculated as follows:
 - $\text{Excess solar power} = \text{Total PV production} - \text{AC loads (without car consumption)} = 1380\text{W} (230\text{V} \times 6\text{A})$

In the example above, the Min. charge current (from 6A) value has been set to 6A. The required excess solar power increases accordingly if a higher value is set for the Min. charge current (from 6A). Please see the chapter [EV Charging Station setup \[13\]](#) for details on both parameters.

2. Manual mode to configure output current

Manual mode allows configurable output current between 6-32A.

The charging power is controlled in several ways:

- By using the web interface via a web browser
- From a GX device touch screen like the [GX Touch 50 & GX Touch 70](#).
- From the Remote Console
- By using the Controls on the Dashboard of the VRM Portal (requires a GX device)
- Via Bluetooth and the VictronConnect App

It allows charging to be started or stopped manually when an EV is connected to the charging station, regardless of PV production.

3. Scheduled mode to allow automatic charging at custom time intervals

The Scheduler allows charging at different time intervals, for example at certain times during the night when grid energy is cheaper.

In addition to the start and end time, various parameters such as charging current and interval can be defined.

The EVCS will then start charging according to the scheduler settings.

WiFi Communication WiFi 802.11 b/g/n for configuration, control and monitoring

The internal WiFi module can be configured in Access Point mode or Station mode, for first setup, control and monitoring.

Bluetooth communication via VictronConnect

Integrated Bluetooth capability enables easy monitoring and control of the EV Charging Station NS via [VictronConnect](#) from any mobile device such as an iPhone, iPad or Android phone.

For more details see the [VictronConnect setup, configuration and operation \[20\]](#) chapter.

Integration with GX devices

Control and monitor the EV Charging Station NS from a GX device such as the [Cerbo GX](#) and the Remote Console.

For more details see the [GX device setup, configuration and operation \[18\]](#) chapter.

Integration with VRM

Several options are available in the VRM Portal:

- Real time reports
- Custom reports for configurable time periods
- Advanced functions such as remote firmware updates
- Change mode and charge current via Dashboard Controls on the VRM Portal and start/stop charging

Control and monitoring is also possible via VRM App (download from App Store or Google Play) and [VRM App Widgets](#) directly from the home screen of a mobile device.

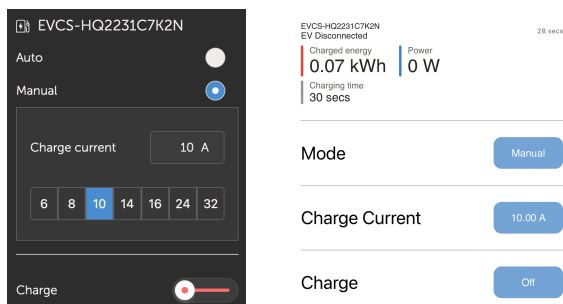

For detailed information, see the [VRM Portal documentation](#).

Light Ring for fast viewing the device state

It also has a fully programmable RGB light ring around the charging port, which can be used to quickly determine the status of the device even from a distance. It can be programmed via the web interface to display different light effects depending on the current state (disconnected, charged, loaded, etc.).

2.3. What's in the box?

- EV Charging Station NS
- Mounting plate
- 28mm nylon cable gland for power cables up to 19mm in diameter
- Type 2 cable plug holder dummy socket
- Rubber plug

3. Installation

This product may only be installed by qualified personnel (licensed electrician).

It is suitable for wall mounting or pole mounting (vertical surface). In all cases, the surface should be solid and flat.

Precautionary measures



- Ensure that the AC input is protected by a fuse or magnetic circuit breaker rated at 40A or less. The cable cross-section must be sized accordingly. If the AC input supply is rated at a lower value, the fuse or magnetic circuit breaker should be sized accordingly.
- We recommend using a RCD type B protected supply. Make sure that the RCD corresponds to the maximum power used, i.e. use a 40A RCD type B if you charge mostly with 22kW or correspondingly smaller if you charge with less power.
- Recommended cable cross-section is 6mm² / AWG 10.
- Inside the device is a sticker with the model, serial number, WiFi password and, depending on the date of manufacture, the unique Bluetooth pairing code. Note the password and pairing code on the internal label for future reference. This initial password can be used for both logging in on the web page but also for WiFi connection.
- The tightening force of the screws on the backing plate should be 1-1.2 Nm.
- The mounting surface should be solid and flat.
- Make sure you always have the latest version of this manual, which is updated regularly and available on the [EV Charging Station](#) website.

Installation steps:

1. Decide whether the power cable should be routed from the bottom or from the rear into the charging station.
2. Remove the blue cover (2 screws at the bottom) from the charging station.
3. Mark the wall where it should be mounted using the supplied wall plate or the [drilling template \[29\]](#) in the appendix.
4. Drill 3 holes with wall plugs ready for installation, see the drilling template in the appendix.
5. Measure a suitable location and drill through the wall for the cable (when main supply cable comes from inside the building). Note that if the cable is fed into the charging station from the rear instead of the bottom, the hole will match the drilling template.
6. Depending on whether the cable is routed from below or from behind, knock out the appropriate hole for the nylon gland with a screwdriver or use a 28mm drill and insert the nylon gland. If the cable is routed from the rear, attach the supplied rubber plug instead and pierce a hole slightly smaller than the power cable into it to make a watertight connection.
7. Label each individual cable and pass it through the wall, the nylon gland (or the rubber plug), the grommet and into the charging station.
8. Terminate the cable ends with ferrules and connect to the relevant points.
9. If this is a single-phase installation, use L1, neutral and earth connections.
10. Tighten the nylon gland if installed from the bottom.
11. Hang the device over the wall plate and fix it with the two screws from inside the device.
12. Attach the blue cover and fix it with the 2 screws from the bottom side. Make sure it is firmly seated.

Watch this video for an installation example:

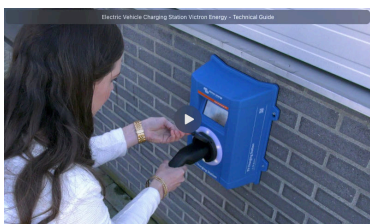

4. System example

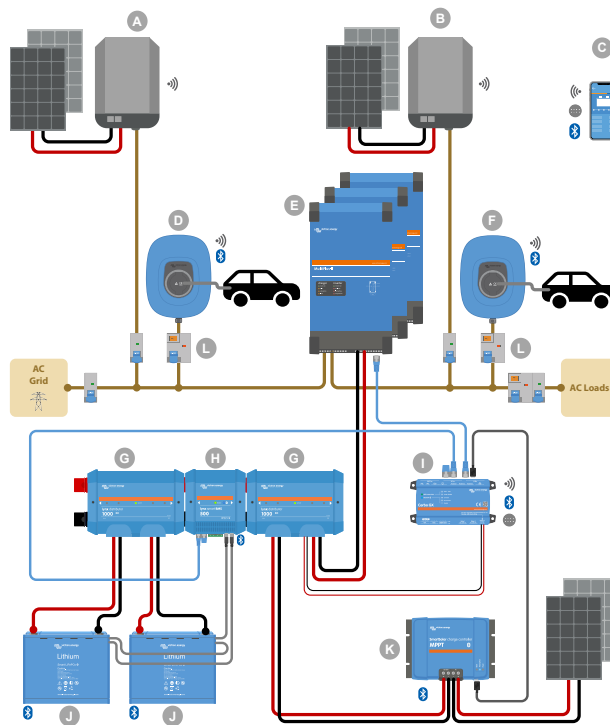

This system displays all available options, specifically:

- All solar types: AC PV on AC input, AC PV on AC output and DC PV
- EV Charging Station NS on AC input or AC output of the inverter/charger
- Single-phase or three-phase

Key	Description
A	Grid-feed PV Inverter connected to the AC input of the inverter/charger
B	Grid-feed PV Inverter connected to the AC output of the inverter/charger
C	Setup, control and monitoring via WiFi or Bluetooth and VictronConnect , web interface or VRM portal (setup only via WiFi or Bluetooth)
D	EV Charging Station NS: Connected to the AC input of the inverter/charger
E	For single-phase systems: a single inverter/charger or inverters/chargers connected in parallel For three-phase systems: three inverter/chargers connected in 3-phase or multiple strings of paralleled units connected in 3-phase
F	EV Charging Station NS: Connected to the AC output of the inverter/charger
G	Lynx Distributor : On the battery side and on the system side, containing a positive and negative bus bar and all DC fuses
H	Lynx Smart BMS : Monitors and controls (with built-in battery monitor and contactor) the Victron Smart Lithium batteries and Lynx Distributor fuses
I	Cerbo GX : Serves as a control and communication center and enables remote control and monitoring via the VRM portal and/or the VRM App Widgets , accessible directly from a mobile device
J	Victron Lithium Battery Smart : Available in 12.8V & 25.6V and different capacities. A maximum energy storage capacity of 102kWh can be achieved by combining batteries in both series and parallel configurations
K	Solar Charge Controller : A variety of MPPT solar charge controllers are available with voltage ranges from 75V to 450V, allowing for topping up of energy storage and storage of surplus energy in the vehicle's battery
L	Dedicated RCD type B (40A for charging at 22kW) on the EV charger input

5. Setup

5.1. First setup

5.1.1. First setup via WiFi access point

The charging station broadcasts its own WiFi access point as soon as the charging station is powered for the first time. The following steps describe the first setup to prepare the charging station for operation.

1. Connect to the WiFi access point:

- I. Scan the QR Code on the internal label.
- II. Or go to the WiFi menu of your mobile device or laptop and manually add the access point that broadcasts automatically its SSID. SSID and WiFi key are noted on a sticker inside the case.

Once connected to the access point, enter the default IP address 192.168.0.1 into a web browser. The First setup process will then start:

2. WiFi setup: Configure the WiFi network by choosing the WiFi mode

- I. **Access point:** The unit creates its own WiFi access point. This is either for setting up the unit or in the absence of a separate WiFi network including a GX device. Set SSID, IP address and Netmask according to your needs.
 1. Set SSID, IP address and Netmask according to your needs.

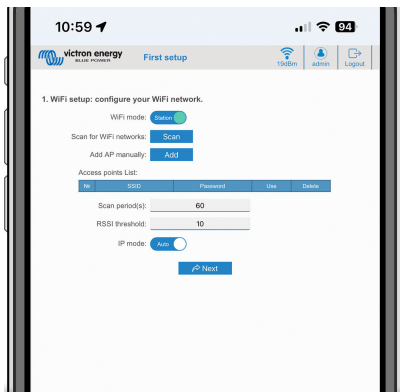

- II. **Station:** Connects the device to a local WiFi network that includes other Victron devices like a GX device or VRM.

1. Change the WiFi mode from AP to Station.

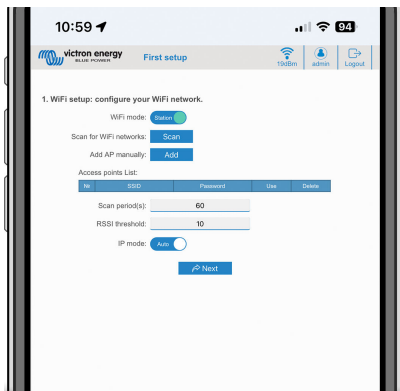

2. Click the Scan button (the scan period and RSSI threshold applies) to search for other WiFi networks or add manually a known AP by clicking the Add button. Note the WiFi standards: 802.11 b/g/n (2.4Ghz only).
3. Tick the network you wish to connect to and then click Apply.

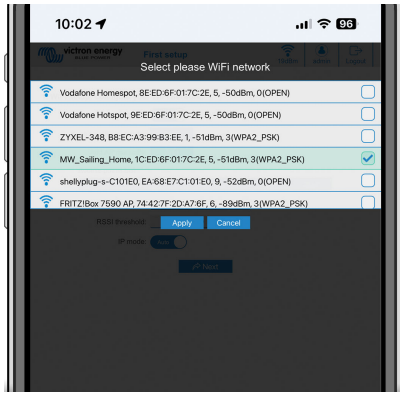

4. In the Password box, enter the external WiFi password and click Next.

In case you need a static IP rather than DHCP, change the IP mode button to Manual and fill in the static IP address, Mask, Gateway and DNS.



3. Access setup:

- I. Click into the Username field and type in your own username. The default username is 'admin'.
- II. Click into the Password field and change the password to a new one with at least 8 characters, containing lower, upper and special characters. The default password is printed on the sticker inside the unit.
- III. Confirm your new password.
- IV. Click Next.

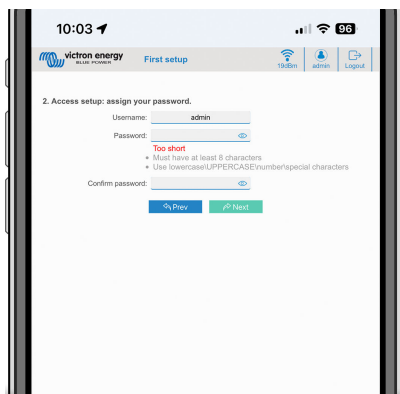

4. Charging current setup:

- I. Set the maximum charging current (10 - 32A).

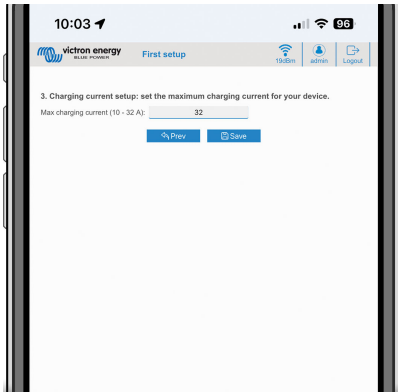

II. Click Save to apply all settings. The system restarts and the login page of the web interface is displayed.

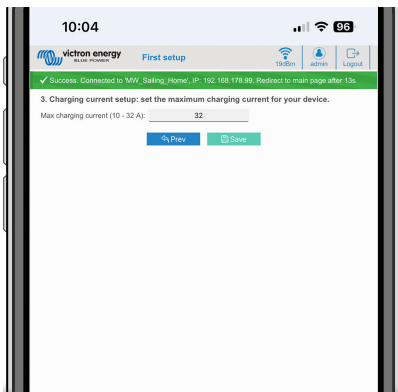

III. Log in with your credentials that you entered under 3.

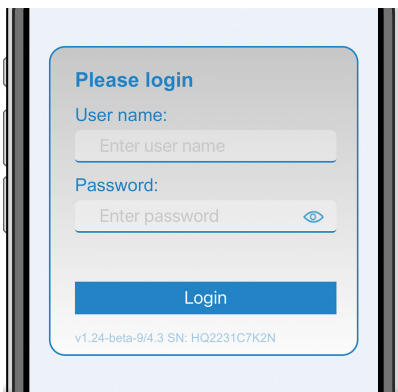

IV. The main page is then displayed and the EV Charging Station NS is ready for use.

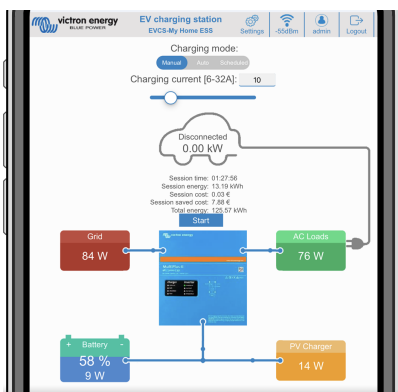

5.1.2. First setup via VictronConnect

The first setup is even easier via VictronConnect.

1. Open VictronConnect and find the entry for your EVCS (EVCS-HQXXXXXXXXXX).
2. Tap on EVCS. This will start the pairing dialogue. Enter the pairing code which is a unique number on a sticker inside the housing.
3. If pairing was successful, the status page will appear; ignore the page for now (using the EVCS is not yet possible) and tap the cog wheel icon in the upper right to open the Settings page.

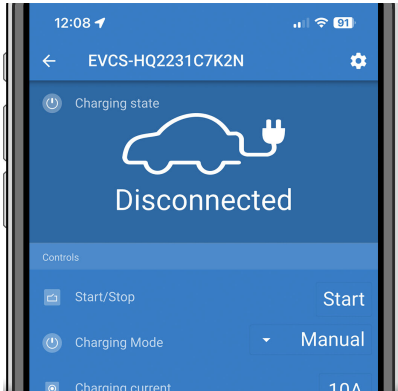

4. Go to the Network settings and tap on it.

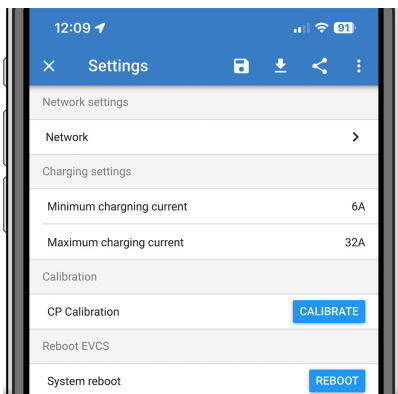

5. One of the following parameters **must** be changed to complete the first setup and start using the EV:

- I. Selected network mode: Access Point

The unit creates its own WiFi access point. This is either for setting up the unit or in the absence of a separate WiFi network including a GX device.

If sticking with AP mode, then change at least the Access Point SSID, the Access Point passphrase or the Access Point IP address in the Wireless Access Point settings.

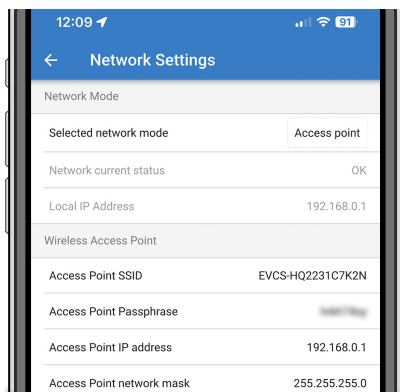

- II. Selected network mode: Connect to local WiFi

Connects the device to a WiFi network that includes other Victron devices like a GX device or VRM.

1. Change the network mode to Connect to local WiFi, hit OK but do not store the settings yet. Leave the Settings changed popup untouched.

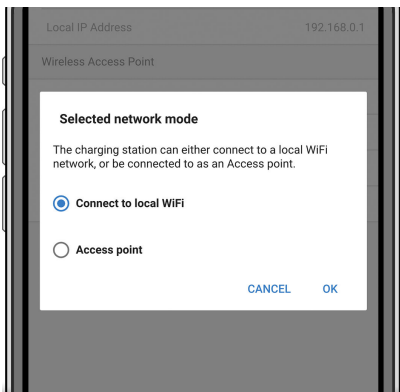

2. Tap on SCAN FOR NETWORKS and make sure you have the password for your local network ready.

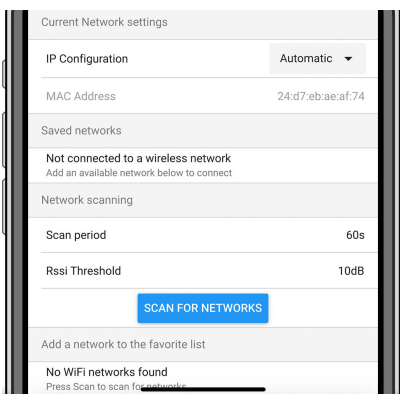

3. Once the scan is complete, a list of available networks will be displayed. Tap ADD for the network of your choice.

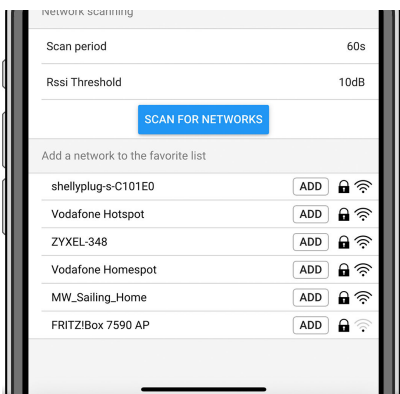

4. Enter the passphrase for this network in the popup and press OK.
5. Change the IP configuration if needed: Automatic (DHCP) or Manual for static IP (requires valid IP address, Netmask, Gateway and DNS from your system administrator).

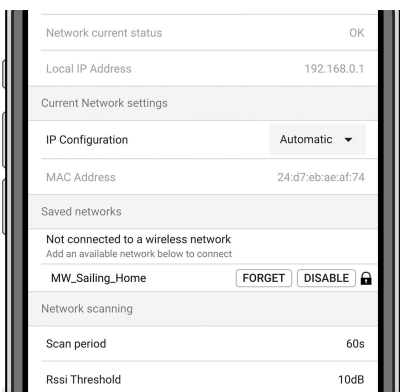

6. Scroll up and tap on STORE SETTINGS to apply the new settings and confirm with YES. The EVCS will automatically connect to the local network.

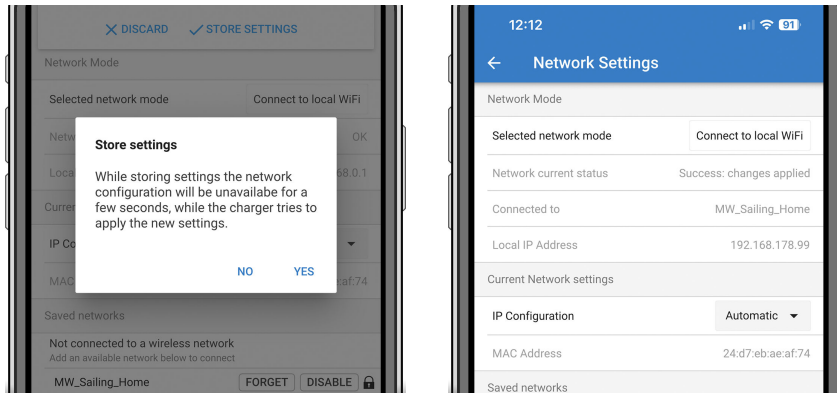

6. The first setup is now finished and the EV Charging Station NS is ready for use. For more details on how to operate the charging station via VictronConnect, see the [VictronConnect setup, configuration and operation \[20\]](#) chapter

5.2. EV Charging Station setup

After initial setup, set up the EVCS according to your needs. To do this, connect to the web interface and click on the Settings tab for further setting options. The main page options are explained in [The main page \[16\]](#) chapter.

Six subtabs will appear:

1. **Networks** tab: See the [Networks menu \[17\]](#) chapter.
2. **General** tab: Provides setting options for the charger, GX device communication, display, time zone and device name.
 - a. **Charger:** Charger related settings.
 - i. **EV charger position:** Select where the EVCS is positioned in the system. Examples:
 1. If the charging station is on the output of an inverter as one of the main's AC outsources, select Inverter AC out.
 2. If connected to the grid and the EVCS is positioned at the AC input of the grid before the inverter, select Inverter AC in.
 - ii. **EV charger autostart:** If this option is enabled, the EVCS will attempt to start charging after the vehicle is connected.
 - iii. **Contactor active when charged:** Keeps the contactor closed after charging. If, for example, an air conditioner is active in the vehicle, it is powered by AC power and not by the car battery.
 - iv. **Maximum charging current:** 10 - 32A
 - v. **Minimum charging current:** From 6A up to 1A below max. value. Example: A Renault Zoe needs at least 10A.
 - vi. **CP line calibration procedure:** If the vehicle is not detected or if the vehicle is fully charged and the EVCS contactor opens/closes, the calibration should be performed.
 - vii. **Power calibration(0.6 - 1.4):** If the displayed power value is not correct, a maximum correction factor of +/- 40% can be applied.
 - viii. **Actual power (kW):** Displays the current power value with which the EV is charged.
 - b. **GX device:** The EV Charging Station NS can be used:
 - i. As a stand alone device in Manual or Scheduled mode. Note that Auto mode requires a GX device and communication between the GX device and EVCS must be enabled.
 - ii. As part of a larger Victron Energy system. When enabling GX device communication, Modbus TCP must be enabled in the GX device (see [Modbus TCP activation \[18\]](#) section) itself to enable communication with the EVCS.
To avoid errors, the easiest way is to have the pairing between the EVCS and the GX device performed automatically. With the Discover function, the EVCS is able to automatically detect the IP address via the VRM Portal ID.
 - A. **Communication:** Enable or disable communication with a GX device.
 - B. **IP address:** The IP address of your GX device. This will be automatically filled in when you use the Discover feature to pair the EVCS with the GX device.
 - C. **VRM Portal ID:** The VRM Portal ID of your GX device. This will be automatically filled in when you use the Discover feature to pair the EVCS with the GX device.
 - D. **Discover:** Click the Discover button to search for the GX device and pair the EVCS with the GX device. Select the GX device from the list that will pop up; the GX IP address and VRM Portal ID will then be entered automatically.
 - E. **Check:** Press this button to check communication with the GX device. The result is displayed at the top of the page.
 - F. **Start charging at backup battery SoC(%):** The minimum backup battery SoC required to start charging in Auto mode.
 - G. **Stop charging at backup battery SoC, if off-grid(%):** Stops charging when the backup battery SoC falls below this value and there is no grid.
 - c. **EVCS ModbusTCP Server:**
EVCS ModbusTCP server. The address is the same as that of the GX device.
 - i. **IP address whitelist state:** Enable or disable the whitelist state.
Note that when the IP address whitelist state is enabled, only the devices from the IP address whitelist table below can communicate with the EVCS.
 - ii. **IP address whitelist table:** Add IP addresses that are allowed to communicate with the EVCS.

d. **Others:**

- i. **Energy price per kWh:** Enter the cost per kWh to calculate the session cost saved.
- ii. **Time zone:** Choose the time zone.
- iii. **Device name:** Change the name of the EV Charging Station NS, which will then also be updated in the GX device, VictronConnect and the VRM portal.

3. **Scheduler** tab: The schedule required for the scheduled mode is created in this menu.

You can schedule scenes to activate automatically under certain conditions. These conditions include:

- a. **Start time:** Start time of the schedule in hh:mm (24h time format applies)
- b. **End time:** End time of the schedule in hh:mm (24h time format applies)
- c. **Current[6-32A]:** Maximum charging current while the schedule is active
- d. **Repeat:** The time interval at which the schedule is automatically executed again. Possible options:
 - i. **Daily:** Repeats daily
 - ii. **Mon-Fri:** Repeated from Monday to Friday
 - iii. **Weekends:** Repeats every weekend
 - iv. **Custom:** Choose the days of the week you want the scene to repeat
- e. **State:** State of the scene. If disabled, the schedule for the scene will not run.

Once a scene has been created, press the Accept button and then the Save button. Note that the scenes are only active when the charging station is in scheduled mode. A currently active scene is highlighted in green in the scheduler and marked active. Scenes can be edited at any time. The same rules apply as described above.

Use the import and export buttons to import/export scenes in .json format.

4. **Light Ring** tab: Customises the ring of lights on the front of the station, around the vehicle socket. A variety of modes to choose from, how long the mode is displayed, the brightness of the lights and their colour.

The coloured ring is to indicate at a glance what the EV Charging Station NS is doing: for example, when the vehicle is fully charged, when there is a low state of charge.

Click the Save button at the bottom of the screen after any change or import/export the Light Ring settings in .json format.

5. **Access** tab: Change the username and password.6. **Backup & FW** tab: Export or import saved settings, reset the charging station back to factory defaults and update firmware manually.

- a. **FW Update:** The EVCS firmware can be updated manually via the web interface or remotely via [VRM: Remote firmware update](#).
 - i. **Select firmware file (*.evcsup):** Press the Open button and browse to the location where the provided firmware file is stored, then click Update. This will start the update process. After a successful update, the charging station restarts and the main page is then displayed again. Note that all settings are retained.
- b. **Backup:** Backup and restore all system settings from/to a .json format file.
- c. **Reset to factory defaults:** Resetting the device to default values can be done in different ways:
 - i. From the webpage by selecting the Backup & FW menu and then press "Reset to factory defaults" or
 - ii. From inside the unit, by pressing the DEF button for more than 15 seconds. See image below. Note that if the DEF button is pressed less than 15 seconds but more than 5 seconds, it will reset the password only.



The DEF button procedure should only be performed by qualified personnel as this process requires the EV Charging Station NS to be powered. Working under high voltage is very dangerous and can be fatal if used incorrectly. Be sure to avoid touching parts in the area marked in red.

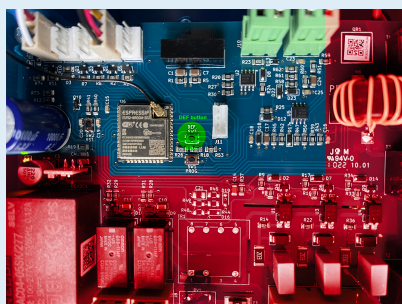

- iii. Via VictronConnect from the product info page.

5.3. The main page

The main page of the web interface provides control and monitoring elements for the EV Charging Station NS. These are from top to bottom:

- Charging mode switch: Change the charging mode to manual, auto or scheduled.
- Charging current slider: Adjust the charging current.
- Start/Stop button: Start or stop charging when in manual mode.
- Session statistics and an animated graphical overview to see the charging progress at a glance.

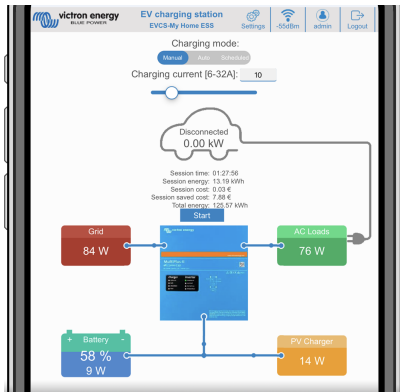

5.3.1. Charging mode switch in detail

The Charging mode switch is located on the main screen and provides three different operation modes:

- **Manual** mode: Enables the user to turn the vehicle charging ON and OFF manually, using the START STOP button. The amount of current the station provides, can be changed using the Charging current slider.
- **Automatic** mode: The system will determine all the settings for the user. Similar to a GX device, the screen shows how the current is flowing. A GX device such as the [Cerbo GX](#) or [Color Control GX](#) must be included in the system for this operation mode to work. There are a variety of settings that can be changed directly from the GX device related to either manual or automatic mode. One can see the device, its summary as well as more advanced power graphs on the main dashboard of the [VRM Portal](#).
- **Scheduled** mode: Charge the EV at certain time intervals, for example during the night hours when grid energy is cheaper.

The manual and automatic modes ensure the best use of the charging station.

The charging mode can be changed via:

- The main web page
- A GX device
- The VRM Portal (requires a GX device in the system)
- Bluetooth and VictronConnect.

The manual mode gives flexibility in choice and charges the car independently of PV production. By manually determining how much power goes into a vehicle charge, you can make allowances for other loads in your home.

The automatic mode ensures maximum efficiency of the PV system and charges excess PV power to the EV before it is fed into the grid.

When the EV Charging Station NS is connected to a Victron system and is in automatic mode, the excess solar power can be used to charge the vehicle instead of, for example, feeding it into the grid at a lower price.

5.4. Networks menu

WiFi options and Bluetooth are configured via the network menu of the web interface. Available options are:

1. WiFi

- a. **WiFi mode:** Toggles between access point and station mode.
 - i. **Access point mode:** The unit creates its own WiFi access point. This is either for setting up the unit or in the absence of a separate WiFi network including a GX device. SSID, password, IP address and Netmask are configurable.
 - ii. **Station mode :** Connects the device to a WiFi network that includes other Victron devices like a GX device or VRM. To do this:
 - A. Change the WiFi mode from AP to Station.
 - B. Click the Scan button to manually search for other WiFi networks or manually add a known AP by clicking the Add button. Note the WiFi standards: 802.11 b/g/n (2.4Ghz only).
 - C. Tick the network you wish to connect to and then click Apply.
 - D. In the Password box enter the external WiFi password and click Next.
 - E. In case you need a static IP rather than DHCP, change the IP mode button to Manual and fill in the static IP address, Mask, Gateway and DNS.
 - F. Click Save. Note that when Station mode is enabled, a WiFi strength indicator appears at the top of the web page.

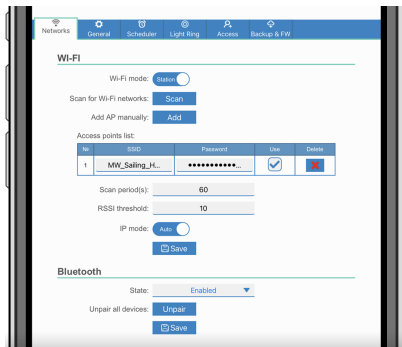

- iii. **Scan period:** If there is only one network to connect to (e.g. a router), the scan period can be set to 0 to avoid unnecessary scanning during an existing connection. If the EVCS connects to more than one network, it is recommended to leave it at the default (60). Note that this is about background network scanning. This parameter has no effect on the manual scan button.
- iv. **RSSI threshold:** An RSSI threshold can be applied to background scanning.

2. Bluetooth

Bluetooth establishes a direct wireless connection between a mobile device and the EV Charging Station NS to control and monitor the EVCS via [VictronConnect](#). The distance is usually a few meters indoors.

The pairing code can be changed via VictronConnect. A factory reset resets the pairing code to factory defaults.

To enable, disable or unpair Bluetooth via the network menu, the following options are available:

- a. **State:** Enables or disables Bluetooth functionality. A change requires pressing the Save button to apply the new status.
- b. **Unpair all devices:** Click to unpair the EVCS from your mobile device(s). Note that this will also restart the charging station and you will still need to remove the pairing from your mobile device's Bluetooth menu.

6. GX device setup, configuration and operation

6.1. Modbus TCP activation

The EV Charging Station NS communicates with the GX device via Modbus TCP. This must first be activated in the GX device and is a mandatory step.

- In the GX device go to Settings → Services → Modbus TCP and enable Modbus TCP.

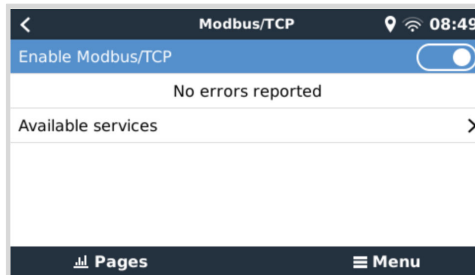

6.2. Setup menu and options

As soon as Modbus TCP has been activated, the EVCS appears in the device list and displays the current mode and charging state.

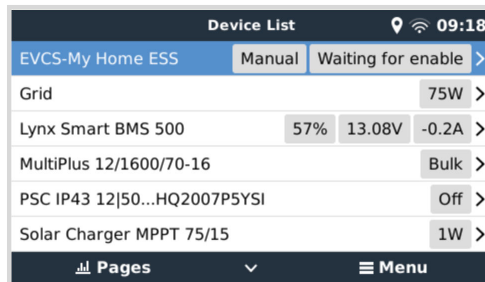

Highlight the EVCS then press spacebar or cursor right to enter the next menu and at the setup menu item press spacebar again to enter the setup menu. See the [EV Charging Station setup \[13\]](#) and the [Description \[2\]](#) chapter for the meaning of the available options.

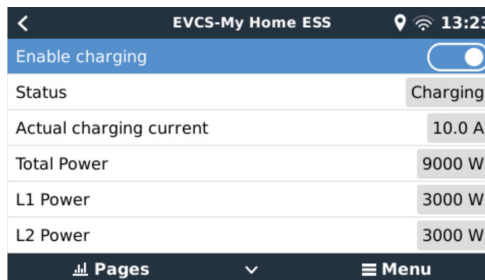

6.3. Overview and device menu

The overview menu provides a button to activate (start) charging in manual mode and the following status information:

- **Actual charging current:** The charging current in A
- **Total power:** Total power of all phases
- **L1..L3:** Power of each individual phase
- **Charging time:** The charging time per session
- **Charged energy:** Charged energy per session

If you scroll further down the menu, you will see the Setup and Device menu. See the [Setup menu and options \[18\]](#) chapter for details.

The last menu item is the Device menu, which provides additional device information such as the connection type, product ID, VRM instance, firmware version and serial number. It is also possible to assign a custom name to the EVCS.

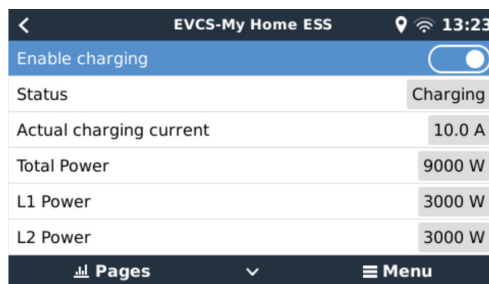

The screenshot shows a mobile application interface for 'EVCS-My Home ESS'. At the top, there is a navigation bar with a back arrow, the title 'EVCS-My Home ESS', and status icons for location, Wi-Fi, and the time '13:23'. Below the navigation bar, there is a toggle switch for 'Enable charging' which is currently turned on. The main content area displays the following information:

Status	Charging
Actual charging current	10.0 A
Total Power	9000 W
L1 Power	3000 W
L2 Power	3000 W

At the bottom of the screen, there is a dark navigation bar with 'Pages' and a dropdown arrow on the left, and 'Menu' with a hamburger icon on the right.

7. VictronConnect setup, configuration and operation

7.1. Setup

The following steps are necessary to successfully connect to the EV Charging Station NS via Bluetooth and VictronConnect:

1. Make sure Bluetooth is enabled in your EVCS.
In case Bluetooth is disabled, see the [Networks menu \[17\]](#) chapter for details on enabling Bluetooth.
2. Download and install the VictronConnect app from the App Store or Google Play.
3. Open VictronConnect and scroll through the list of devices for the EVCS.
4. Tap on it to launch the pairing dialog. Enter the pairing code which is the unique number on the sticker inside the housing.
5. If the pairing was successful, the EVCS overview page is displayed.

7.2. Overview page

The overview page provides information about the charging state, controls to start/stop charging or changing the charging mode and charging current. Furthermore, the actual charging values and session statistics can be monitored.

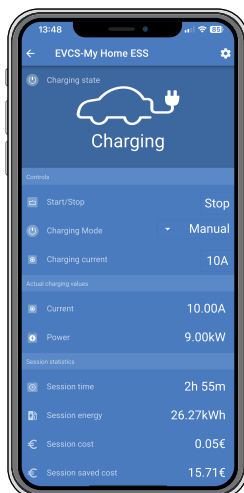

Controls:

- **Start/Stop:** Start or stop charging when in manual mode.
- **Charging mode:** Change the charging mode to manual, auto or scheduled.
- **Charging current:** Adjust the charging current (range: 6-32A, depending on the Maximum charging current set on the Settings page or on the web interface)

Actual charging values:

- **Current:** The charging current
- **Power:** Charging power (of all phases)

Session statistics:

- **Session time:** The time of the actual charging session
- **Session energy:** Total energy charged in this session
- **Session cost:** The session cost (when charged from grid) depending on the energy price per kWh set in the EVCS settings, see the [EV Charging Station setup \[13\]](#) chapter.
- **Session saved cost:** Saved cost based on energy charged from PV and depending on the energy price per kWh set in the EVCS settings.

- **Total Energy:** The total energy charged since initial installation.

7.3. Settings page

The Settings menu offers the possibility to change the network settings, adjust the minimum and maximum charge current, recalibrate the CP line or restart the EVCS.

To get to the Settings menu, tap the cog wheel icon from the Overview menu in the top right.

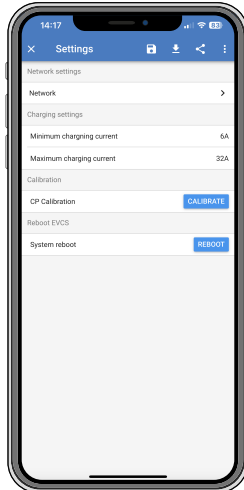

The settings are similar to those explained in the [Networks menu \[17\]](#) and [EV Charging Station setup \[13\]](#) chapter, with the exception that it is possible to trigger a system reboot if required.

7.4. Product info page

The Product info page provides options to change the PIN code for Bluetooth pairing, assign a custom name to the EV Charging Station NS and disable Bluetooth^[1]. It also contains the serial number and the current firmware version number.

To get to the Product info page, tap the 3 vertical dots icon from the Settings page.

More about how to assign your own name to your EV Charging Station NS and how to deactivate and reactivate Bluetooth, please refer to the [VictronConnect App manual](#).

^[1] Note that if you disable Bluetooth via VictronConnect, it can be re-enabled via the web interface [Networks menu \[17\]](#) or by using the [Reset to factory defaults \[22\]](#) feature, either via the web interface or the DEF button procedure. For older devices that have Bluetooth disabled from the factory, use the web interface's network menu to enable Bluetooth.

7.5. Reset to defaults

It is possible to factory reset the EV Charging Station NS via VictronConnect. Note that this process will reset **all** settings to their default values and require the first setup (see the [Setup \[7\]](#) chapter for details) to be performed again.

To get to the Reset to defaults option, tap the 3 vertical dots icon from the Settings page and tap on Reset to defaults.

8. Reset to factory defaults and password recovery

In case the password is lost, the initial password can be recovered in different ways:

Reset to factory defaults from the web interface:

1. Click on the Settings button.
2. Click on the Backup & FW button.
3. Click on Reset to factory defaults.

Reset to factory defaults via VictronConnect:

1. Open VictronConnect and tap on the EVCS from the My devices list.
2. On the Status screen, tap on the cog wheel icon in the top right.
3. On the Settings page, tap on the three vertical dots icon and choose Reset to defaults.
4. A warning will appear that **all** settings will be reset to factory defaults. Tap YES to reset to factory defaults.



Reset to factory defaults will reset **all** system settings to default values. The [First setup \[7\]](#) must be performed again.

Reset the password using the DEF button inside the device:



The procedure described below should only be performed by qualified personnel as this process requires the EV Charging Station NS to be powered. Working under high voltage is very dangerous and can be fatal if used incorrectly.

1. Open the unit by removing the backing plate. **Be careful not to touch the high power parts inside the unit.** Only the area around the DEF button is safe.
2. Press the DEF button (see the image in [chapter 4.3. \[13\]](#) for its location) for more than 5 seconds but less than 15 seconds. This will reset only the password, all other settings are retained.
3. Mount the backing plate onto the device and tighten the screws.

9. Troubleshooting

9.1. CP Line Calibration

What is CP?

CP is the control pilot signal (line) inside each Type2 charger connector. It is a bi-directional communication line that enables communication between the charging station and the EV. Among other things, the charging station informs the EV of the maximum charging current available. At the same time, the EV informs the charging station about its status, for example whether the EV is connected or whether it is currently charging.

Why is CP line calibration necessary?

Due to differences in cable length and manufacturer as well as deviations in the ratings of electronic components, the CP signal may show deviations. The CP calibration takes the signal deviation into account and adjusts the signal values to the required ranges.

When does the calibration of the CP line have to be carried out?

There are several reasons for a CP line calibration. The most important are:

- The EV is connected to the EVCS via the charging cable, but still reports a disconnected state
- When charging the EV, the EVCS frequently switches between the 'charging' and 'charged' states
- The EVCS does not start charging after connecting the vehicle because it cannot detect the correct state after connection

How is a CP line calibration carried out?

The CP calibration can be done via the web interface (Settings → General → Charger → CP calibration or via VictronConnect (Settings page). The procedure is as follows:

1. Press the calibration button
2. Connect the EV to the EVCS and then tap on Next in VictronConnect
3. Press the 'Vehicle is connected' button to confirm that the EV is indeed connected to the EVCS (or tap on Next in VictronConnect)
4. Wait until the EVCS has completed the calculation

Once the calibration is complete, a message is displayed indicating that the calibration was successful

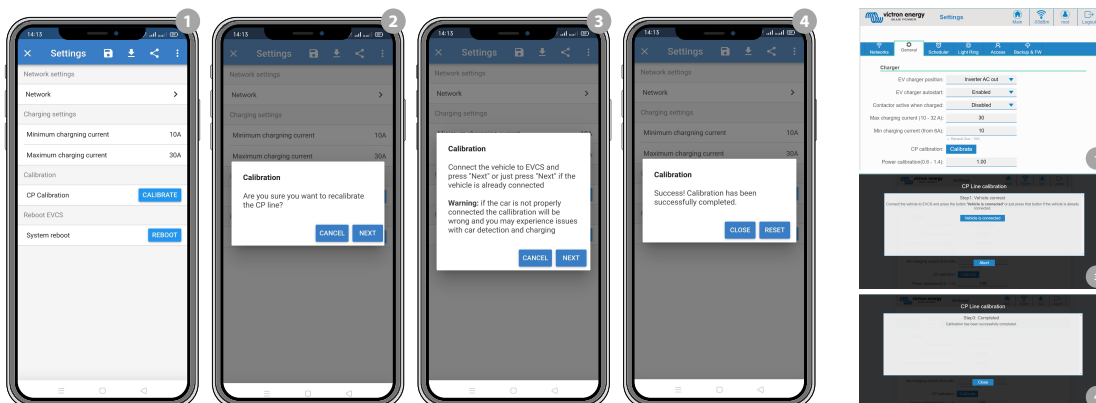

9.2. Frequently asked questions

9.2.1. Q1: How do I prevent the charging station from being used by unauthorised persons?

Make sure EV charger autostart is disabled in general settings. This prevents the charging station from starting to charge automatically once it is connected to an EV.

Charging can then only be started or stopped via the web interface, VRM App widget, VRM controls and VictronConnect.

9.2.2. Q2: Does the EV Charging Station have RFID?

No. To prevent the charging station from being used by unauthorised persons, see Q1.

9.2.3. Q3: The light ring is annoying my neighbours during night, how can I disable the light ring?

You can completely disable the light ring in the light ring menu, changing the brightness to 0 or a lower level if you like.

9.2.4. Q4: Why isn't my car recognized when I connect the charging cable?

Try calibrating the CP line (general tab in the web interface or in the VictronConnect settings). This is sometimes necessary because the charging cables can differ slightly. Ground impedance is also important as all measurements are relative to ground (GND).

9.2.5. Q5: Why does my EV Charging Station show up on multiple GX devices?

If there are several GX devices on the same local network, activate the IP address whitelist in the General tab of the web interface and then add only the IP address of the GX device with which the EVCS is to be controlled to the whitelist. After doing this, remove the EVCS from the other GX devices.

9.2.6. Q6: How much PV power do I need at least to charge the EV in automatic mode?

The minimum current for charging an EV is 6A@230V. You therefore need more than 1.3kW.

However, this may not be sufficient under certain circumstances, e.g. if AC loads are still being supplied at the same time. Charging only takes place if there is enough excess solar power, which is calculated as follows:

Excess solar power = Total PV production - AC loads (without car consumption) = 1380W (230V x 6A)

Note that there are EVs that require an even higher minimum charging current, e.g. the Renault Zoe; 10A, which further increases the minimum PV power required.

9.2.7. Q7: Is it possible to operate multiple EV Charging Stations in one system?

Yes, this is possible. The available power is then shared between them.

9.2.8. Q8: The EV is fully charged, but the EVCS still alternates between start charging and stop charging, why?

The reason is most likely that the EVCS cannot correctly decode the 'charged' signal coming from the EV. Perform the [CP line calibration \[23\]](#) to remedy the problem.

9.2.9. Q9: I keep getting a GX device communication error! The minimum SoC cannot be checked. What is the reason for this?

GX device communication error! Minimal SOC can't be checked.

This error indicates that the EVCS cannot read the SoC from the GX device because there is a communication problem even though communication with the GX device is enabled in the EVCS web interface.

To remedy the problem, make sure that the IP address specified in the general settings of the web interface matches that of the GX device. Use the Discover function to allow the EVCS to derive the correct IP address from the VRM Portal ID - for more details, see the [EV Charging Station setup \[13\]](#) chapter. Also make sure that [ModbusTCP is enabled \[18\]](#) in the GX device itself.

9.2.10. Q10: Is a GX device in the system absolutely necessary?

This depends on the operation mode.

For automatic mode, communication between a GX device and the EVCS is mandatory. For manual and scheduled mode, a GX device can be installed, but does not have to be.

9.2.11. Q11: I would like to control the EVCS via Modbus TCP. Is this possible and if so, how?

Yes, this is possible. Modbus TCP offers a much higher degree of flexibility and control and provides access to a broader range of settings than what is described in the manual or available through the normal user interfaces.



Note that changes to the settings via Modbus TCP will void any support.

The recommended method for support on Modbus-TCP questions is to use the [Modifications section on Victron Community](#). Its frequently visited by many people using Modbus TCP and other methods of integrating with Victron products.

The EVCS Modbus TCP register list can be downloaded from the [product page](#) in the download area.

10. Maintenance

The EV Charging Station NS does not require specific maintenance.

11. Technical specification

EV Charging Station NS	
Input voltage range (V AC)	170 – 265VAC 50Hz
Rated charge current	32A / phase
Nominal power	22kW
Current output range	6 – 32A
Wi-Fi standards	802.11 b/g/n (2.4Ghz only)
Self-consumption	15mA@230V
Configurable Max. Current	10-32A
Configurable Min. Current	6A up to 1A below max. value
Connector type	IEC 62196 Type 2
GENERAL	
Means to Disconnect	Depending on available input power and cable cross-section - max 40A
Configurable price/kWh calculator (EUR)	Default setting: 0.13 (adjustable)
Control type	Web page, GX device over Modbus TCP, VictronConnect via Bluetooth
Light Ring	55 configurable light effects available
Protection	External RCD is required
Operating temperature	-25°C to +50°C
Storage temperature	-40 °C to +80 °C
Humidity	95%, non-condensing
Data communication	ModbusTCP over WiFi, Bluetooth
ENCLOSURE	
Enclosure colour	Light Blue (RAL 5012), Traffic Black (RAL 9017), Traffic White (RAL 9016)
Power terminals	6-10 mm ² / AWG 10-8
Protection category	IP44
Ventilation	not required
Weight	3 kg
Dimensions (h x w x d)	372 x 292 x 122mm
STANDARDS	
Safety	IEC 61851-1, IEC 61851-22 Detection for Relay Contact welded Detection for missing protective conductor Detection for missing Ground Detection for shorted CP

12. Appendix

12.1. Dimensions

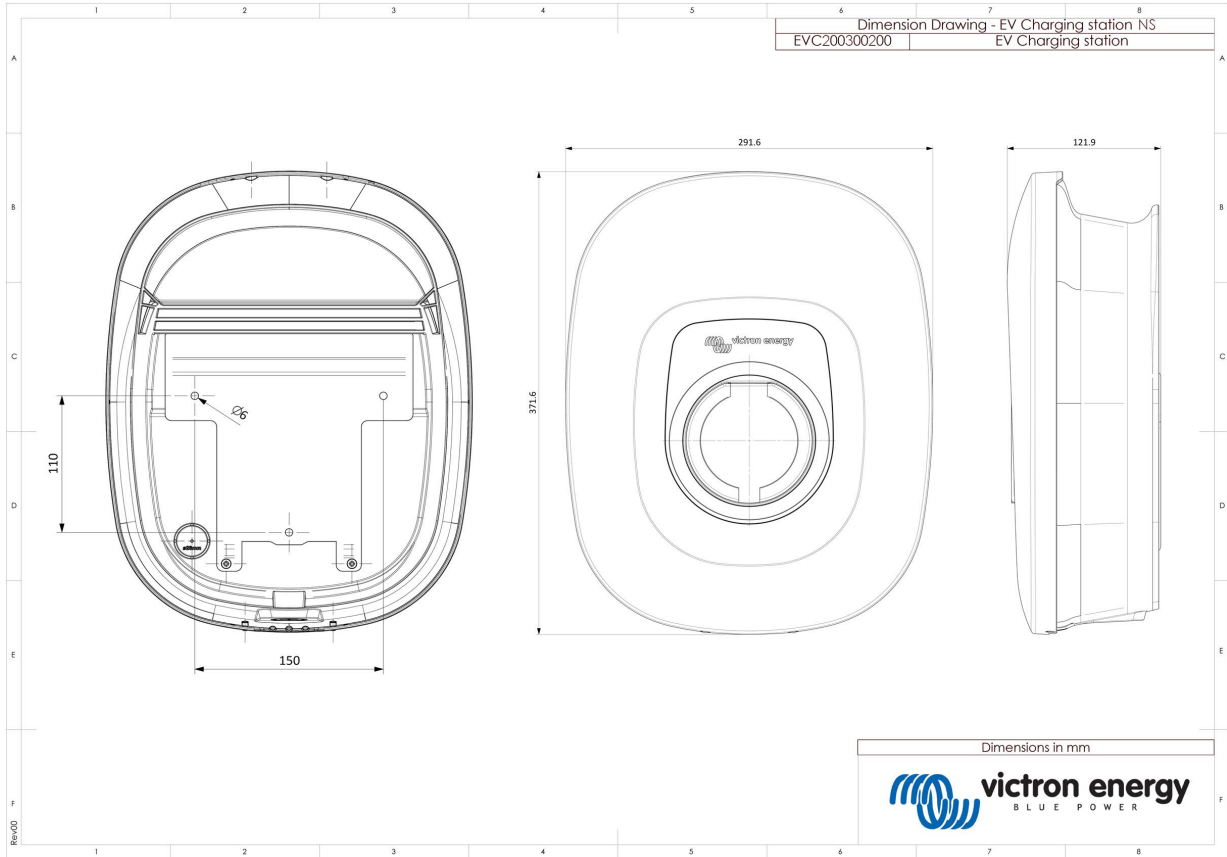

12.2. Drilling template

