

# MultiPlus-II GX Inverter/Charger

MultiPlus-II 24/3000/70-32 GX, 48/3000/35-32 GX & 48/5000/70-50 GX

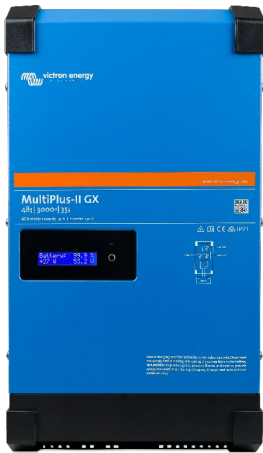

## A MultiPlus-II with LCD and GX functionality

The MultiPlus-II GX integrates a MultiPlus-II inverter/charger and a GX device with a 2 x 16 character display.

### Display and Wi-Fi

The display reads battery, inverter and solar charge controller parameters. The same parameters can be accessed with a smartphone or other Wi-Fi enabled device.

### GX device

The integrated GX device includes:

- A BMS-Can interface. This can be used to connect to a compatible CAN-bus managed battery. Note that this not a VE.Can compatible port.
- A USB port.
- A Ethernet port.
- A VE.Direct port.

### Applications

The MultiPlus-II GX is intended for applications where additional interfacing with other products and/or remote monitoring is required, such as on-grid or off-grid energy storage systems and certain mobile applications.

### Parallel and three phase operation

Only one GX unit is needed in case of Parallel and three phase operation.

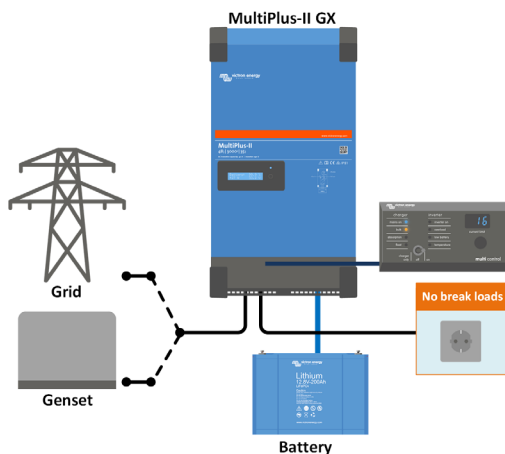

### Standard marine, mobile or off-grid application

Loads that should shut down when AC input power is not available can be connected to a second output (not shown). These loads will be taken into account by the PowerControl and PowerAssist function in order to limit AC input current to a safe value when AC power is available.

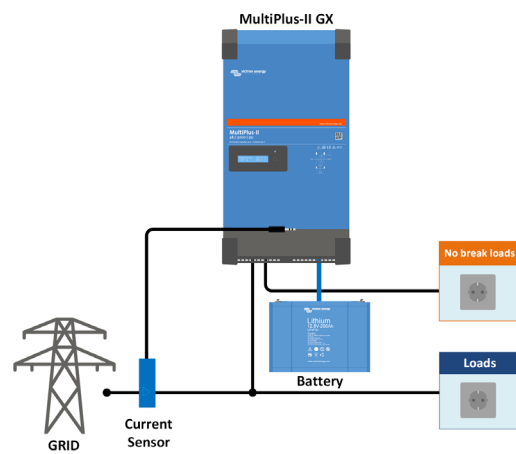

### Standard mobile or off-grid application with external current sensor

Maximum current sensing range: 50 A resp 100 A

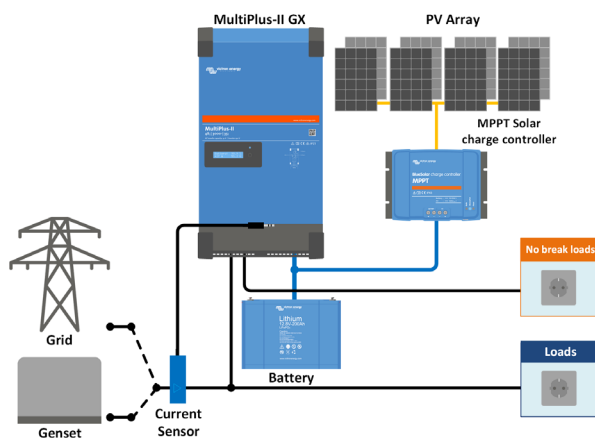

### Grid parallel topology with MPPT solar charge controller

The MultiPlus-II will use data from the external AC current sensor (must be ordered separately) or power meter to optimise self-consumption and, if required, to prevent grid feed. In case of a power outage, the MultiPlus-II will continue to supply the critical loads

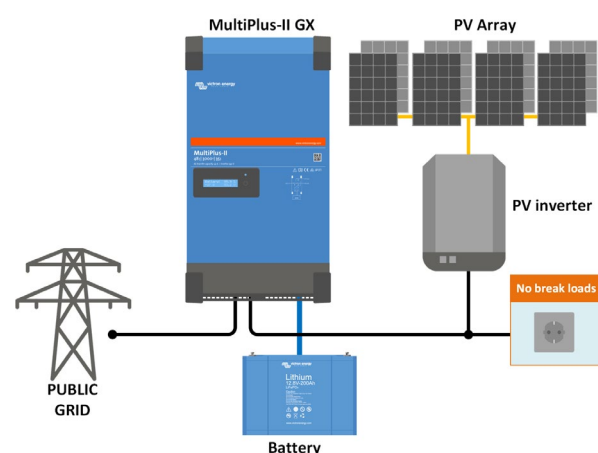

### Grid in-line topology with PV inverter

PV power is directly converted to AC. The MultiPlus-II will use excess PV power to charge the batteries or to feed power back into the grid, and will discharge the battery or use power from the grid to supplement a shortage of PV power. In case of a power outage, the MultiPlus-II will disconnect the grid and continue to supply the loads.



### VRM Portal

Our free remote monitoring website (VRM) will display all your system data in a comprehensive graphical format. System settings can be changed remotely via the portal. Alarms can be received by e-mail.



### VRM app for Wi-Fi

Monitor and manage your Victron Energy system from your smart phone and tablet. Available for both iOS and Android.



### GX GSM

A cellular modem; providing a mobile internet for the system and connection to Victron Remote Management (VRM). Optional: outdoor GSM antenna and GPS antenna. For more detail please enter *GX GSM* in the search box on our website



Connection Area



### Current sensor 100 A:50 mA

To implement PowerControl and PowerAssist and to optimize self-consumption with external current sensing. Maximum current: 50 A resp. 100 A. Length of connection cable: 1 m.



### Digital Multi Control Panel

A convenient and low-cost solution for remote monitoring, with a rotary knob to set PowerControl and PowerAssist levels.

MultiPlus-II GX	24/3000/70-32	48/3000/35-32	48/5000/70-50
PowerControl & PowerAssist	Yes		
Transfer switch	32 A	50 A	
Maximum AC input current	32 A		
Auxiliary output	Yes (32 A)		
<b>INVERTER</b>			
DC Input voltage range	19 – 33 V	38 – 66 V	
Output	Output voltage: 230 VAC ± 2 % Frequency: 50 Hz ± 0,1 % (1)		
Cont. output power at 25 °C (3)	3000 VA	5000 VA	
Cont. output power at 25 °C	2400 W	4000 W	
Cont. output power at 40 °C	2200 W	3700 W	
Cont. output power at 65 °C	1700 W	3000 W	
Maximum apparent feed-in power	3000 VA	5000 VA	
Peak power	5500 W	9000 W	
Maximum efficiency	94 %	95 %	96 %
Zero load power	13 W	11 W	18 W
Zero load power in AES mode	9 W	7 W	12 W
Zero load power in Search mode	3 W	2 W	2 W
<b>CHARGER</b>			
AC Input	Input voltage range: 187-265 VAC Input frequency: 45 – 65 Hz		
Charge voltage 'absorption'	28,8 V	57,6 V	
Charge voltage 'float'	27,6 V	55,2 V	
Storage mode	26,4 V	52,8 V	
Maximum battery charge current (4)	70 A	35 A	70 A
Battery temperature sensor	Yes		
<b>GENERAL</b>			
Interfaces	BMS-Can, USB, Ethernet, VE.Direct, Wi-Fi		
External AC current sensor (optional)	50 A	100 A	
Programmable relay (5)	Yes		
Protection (2)	a – g		
VE.Bus communication port	For parallel and three phase operation, remote monitoring and system integration		
General purpose com. port	Yes, 2x		
Remote on-off	Yes		
Operating temperature range	-40 to +65 °C (fan assisted cooling)		
Humidity (non-condensing)	max 95 %		
<b>ENCLOSURE</b>			
Material & Colour	Steel, blue RAL 5012		
Protection category	IP22		
Battery-connection	M8 bolts		
230 V AC-connection	Screw terminals 13 mm <sup>2</sup> (6 AWG)		
Weight	19 kg	30 kg	
Dimensions (h x w x d) mm	506 x 275 x 147	565 x 323 x 148	
<b>STANDARDS</b>			
Safety	EN-IEC 60335-1, EN-IEC 60335-2-29, EN-IEC 62109-1, EN-IEC 62109-2		
Emission, Immunity	EN 55014-1, EN 55014-2 EN-IEC 61000-3-2, EN-IEC 61000-3-3 IEC 61000-6-1, IEC 61000-6-2, IEC 61000-6-3		
Uninterruptible power supply	IEC 62040-1		
Anti-islanding	Please consult the certificates on our website.		
1) Can be adjusted to 60 Hz	3) Non-linear load, crest factor 3:1		
2) Protection key:	4) At 25 °C ambient		
a) output short circuit	5) Programmable relay which can be set for general alarm, DC under voltage or genset start/stop function.		
b) overload	AC rating: 230 V / 4 A, DC rating: 4 A up to 35 VDC and 1 A up to 60 VDC		
c) battery voltage too high			
d) battery voltage too low			
e) temperature too high			
f) 230 VAC on inverter output			
g) input voltage ripple too high			