

MANUAL

Power Battery 3.8 / 5.7 / 7.6 / 9.6 / 11.5

EN

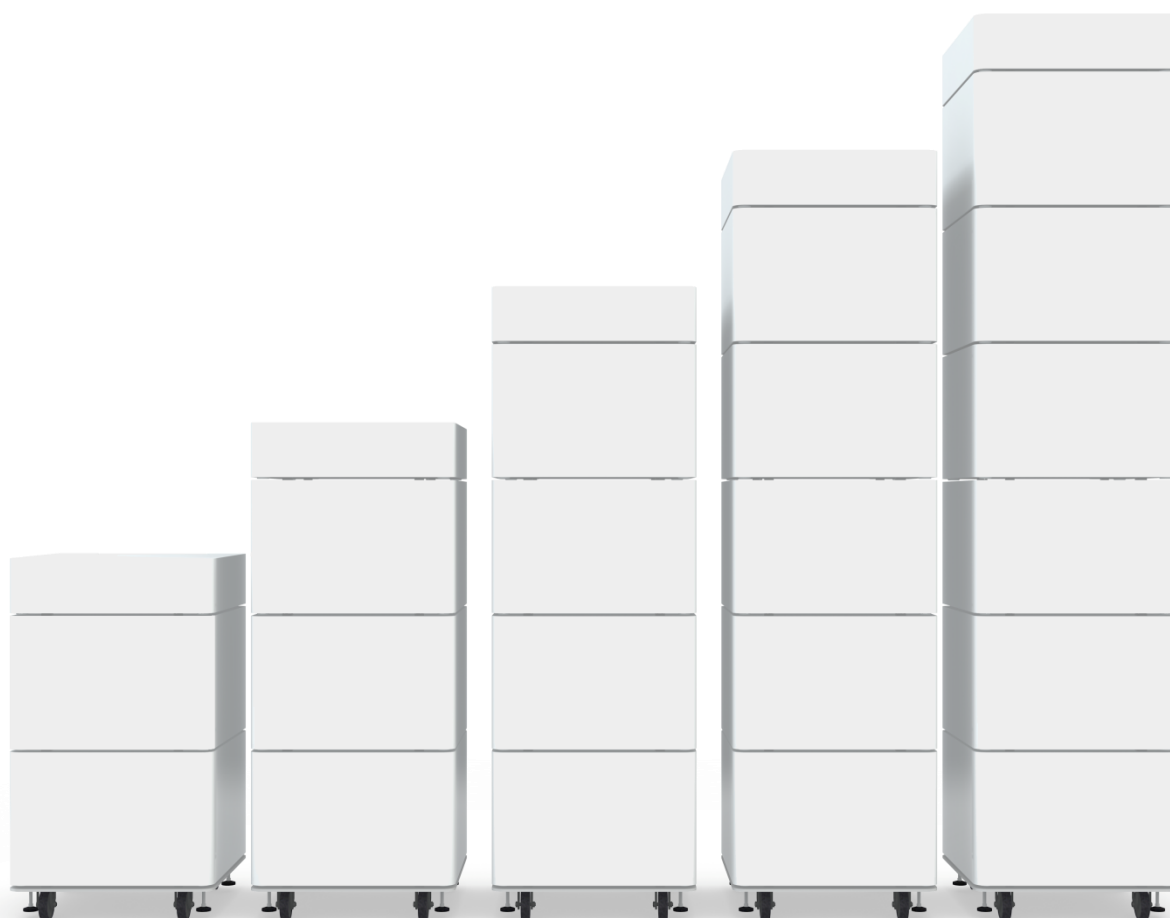

Copyright

Copyright © 2016 RCT Power GmbH. All rights reserved.

This user manual may only be reprinted or copied in whole or in part with the express, written approval of RCT Power GmbH.

Any type of reproduction, distribution, translated, or transmitted in any form or by any means, electronic or mechanical, including photocopying, recording, or storing in any information storage and retrieval system, without an authorized by RCT Power GmbH represents a violation of the applicable copyright laws and will be prosecuted.

We reserve the right to make technical changes that improve the equipment or increase the safety standard, even without a separate announcement.

Responsible for content: RCT Power GmbH

This user manual contains products and product names which are registered trademarks.

The mention of products and product names is used only for information purposes and does not represent product misuse.

Names or brands may be registered trademarks although trademark sign may be missing in this document.

Trademarks are recognized whether marked or not.

About us:

RCT Power GmbH

Line Eid Str. 1

78467 Konstanz, Germany

Phone: +49 (0)7531 996 77-0

Mail: info[at]rct-power.com

Internet: www.rct-power.com

Document number: 01/2021

Table of Contents

1	ABOUT THIS DOCUMENT	1
1.1	Validity, purpose and scope of the document and legal provisions	1
1.2	Symbols- and note explanation.....	1
2	SAFETY INSTRUCTIONS	2
2.1	Personnel and qualifications.....	2
2.2	Safety precautions	3
2.3	General safety information.....	4
3	PRODUCT INTRODUCTION	5
3.1	Intended usage.....	5
3.2	Product description.....	6
3.2.1	Scope of delivery	6
3.2.2	Product Appearance	9
3.2.3	Name plate and warnings.....	12
4	MECHANICAL INSTALLATION	14
4.1	Place of installation	14
4.2	Mounting.....	16
5	ELECTRICAL CONNECTION	18
5.1	Wiring Power Battery.....	18
5.1.1	Protective earth connection	18
5.1.2	Communication connection.....	19
5.1.3	DC connection	20
5.2	Battery connection to the inverter	21
5.2.1	Assembly of DC connection conductor	21
5.2.2	Preparation for wiring to the inverter.....	23
5.2.3	Fix the Power Battery on the wall.....	23
5.2.4	Connection to Power Storage DC 4.0 / 6.0.....	24
5.2.5	Connection to Power Storage DC 8.0 / 10.0.....	24
5.2.6	Connection to Power Storage AC.....	24
6	COMMISSIONING	24
7	MAINTENANCE	25
7.1	Maintenance	25
7.2	Incident announcement	25
8	STORAGE, CLEANING AND DISPOSAL	26
8.1	Storage	26
8.2	Cleaning.....	26
8.3	Disposal.....	26
9	EXCLUSION OF LIABILITY	26
10	APPENDIX	27
11	TECHNICAL DATA	28

Foreword

Thank you for choosing a Power Battery from RCT Power GmbH!

You have obtained an innovative, high-quality product with unique features and consistently high efficiency.

RCT Power Battery has a modular design, is highly flexible and robust, thus the system is easy to use.

Therefore it can be adapted to individual customer requirements. These devices will bring more profit from your PV system.

The battery system is equipped with a safe and efficient battery management technology (Power Battery Master).



Keep this manual in a convenient place for future reference.

Declaration of conformity

The company **RCT Power GmbH** hereby declares, that the described battery system in this document is in accordance with the essential requirements and the other relevant provisions of the guidelines below.

- Directive 2014/30/EC
(Electromagnetic Compatibility, EMC)
- Directive 2014/35/EC
(Low Voltage Directive)

For a detailed EU declaration of conformity, please visit:

www.rct-power.com

1 About this document

1.1 Validity, purpose and scope of the document and legal provisions

This document is valid for Power Battery 3.8, 5.7, 7.6, 9.6 and 11.5.

Power Battery 3.8, Power Battery 5.7, Power Battery 7.6, Power Battery 9.6 and Power Battery 11.5 will be referred to as "battery", "battery system", "accumulator", "stack", "device" or "product" hereinafter unless specified otherwise.

The battery consists of at least 2 Power Battery Stacks with 3,8kWh.

It can be extended up to max. 6 Stacks with 11,5kWh.

In each Power Battery is one Power Battery Master included.

This setup manual contains a general instruction required for installing, wiring, commissioning and operating the battery.

RCT Power GmbH shall not be responsible for any damages resulting from use of this document.

This document does not replace any applicable laws, regulations, standards or codes.





Warranty conditions come enclosed with the device. No warranties can be derived from this document.

Note:

The Power Battery is a Class A device.

1.2 Symbols- and note explanation

Important instructions contained in this manual should be followed during installation, operation and maintenance of the battery. They will be highlighted by the following symbols.

Symbol and Note	Description
 DANGER	This symbol indicates an immediate danger with a high level of risk which, if not avoided, will result in death or serious injury.
 WARNING	This symbol indicates an immediate danger with a medium level of risk which, if not avoided, could result in death or serious injury.
 CAUTION	This symbol indicates an immediate danger with a low level of risk which, if not avoided, could result in minor or moderate injury.
 NOTICE	This symbol indicates a situation which, if not avoided, could result in equipment or property damage.
	This symbol indicates important additional information, emphasized contents or tips which contribute to a better understanding of the Power Battery.

2 Safety instructions

2.1 Personnel and qualifications



To prevent personal injury or material damage, the inverter and the battery must only be installed, wired, connected, commissioned, maintained and serviced by qualified personnel.

Qualified personnel eligible to perform the tasks described in this document have following skills and knowledge:

- They are trained in installing electrical devices.
- They understand the functions of a battery system and know how it operates.
- They are familiar with lithium iron phosphate (LiFePO₄) batteries.
- They have read and understood the documents shipped with the device.
- They know and use the appropriate tools and equipment to perform the work.
- They are familiar with all applicable laws, regulations, standards and codes for electrical devices.
- They are familiar with safety requirements and safety-related guidelines for electrical devices.
- They are familiar with national work protection laws and regulations.
- They know and use the appropriate personal protective equipment.

2.2 Safety precautions

The Power Battery has been designed and tested strictly according to the international safety regulations. All safety instructions related to the electrical and electronic device must be complied with during installation, operation and maintenance.



DANGER

Risk of death or serious injury due to electric shock!

Metal parts of the batteries are always under voltage. Do not short-circuit the batteries! In case of a short-circuit, may flow very high currents and cause burns. By Touching conductive parts can cause cardiac arrhythmia and shock.

- Any work on the batteries, in particular their installation and maintenance, may only be carried out by trained personnel. Which is familiar with the handling of batteries and the necessary precautions.
- Do not touch bare battery parts, connectors, terminals and poles!
- Always keep watches and ornaments away from the batteries.
- Do not enable voltage connections until electrical work is finished.
- Make sure other persons keep away from cables and inner battery parts.
- Use only accessories and spare parts approved by RCT Power GmbH. Never modify the battery or components of the Power Battery.



WARNING

Risk of death or serious injury due to electric arc!

Installations, service and maintenance work may only be carried out by Qualified electrician.

- Do not immerse the product in any liquid or expose it to moisture.
- Do not expose the product to impact or pressure.
- Do not place tools or other metal objects on a battery.



CAUTION

Without proper battery operation, the safety and reliability of the power supply is not guaranteed in an emergency.

- Switch off the Power Battery in event of a an error and contact the customer service.
- Do not cover Power Battery (especially upper side).
- Do not operate the Power Battery over +40°C.
- Do not store the Power Battery Stacks in locations under -5°C or above 45°C.
- For cleaning, use only a damp and clean cotton cloth.



NOTICE

- All electrical installations must be made in accordance with local and national standards and regulations.
- In order to prevent personal injury make sure that electrically conductive surfaces of the Power Battery system are grounded.
- Malfunction might impair the battery safety. Do not operate or restart Power Battery, if it shows any visible damage or if error message is unclear.
- Power Battery contains no owner serviceable parts. Please contact local authorized personnel if any service work is required.
- Do not remove nameplate of Power Battery.

2.3 General safety information

Symbol and Note	Description
	Acid traces in the eyes or on the skin clean with lot of clear water. Then consult a doctor immediately! Wash contaminated clothing with plenty of water.
	Fire- extinguisher for abatement from initial fire.
	Warning! Metal parts of the batteries are always under voltage. Do not short-circuit the batteries! In case of a short-circuit, may flow very high currents and cause burns. By Touching conductive parts can cause cardiac arrhythmia and shock.
	Warning! To prevent personal injury or material damage, the inverter and the battery must only be installed, wired, connected, commissioned, maintained and serviced by qualified personnel.
	Explosion risk! It is strictly forbidden to clean with synthetic cloths or a feather duster. Otherwise there is the risk of electrostatic charging or discharging.
	Electrolyte is highly corrosive! In normal operation, contact with the electrolyte is not possible. In the case of destruction of the housing, the liberated bound electrolyte is just as corrosive as liquid electrolyte.
	Warning of battery hazards.
	Caution! Children should be keep away from the battery system.
	No smoking! Do not expose the battery to open flame, heat or sparks, as there is a risk of fire or explosion.

3 Product introduction

3.1 Intended usage

Power Battery 3.8, 5.7, 7.6, 9.6 and 11.5 are stationary battery systems with lithium iron phosphate accumulators (LiFeP04).

A Power Battery in connection with a Power Storage is a smart and highly efficient system that stores the generated PV energy from the solar generator and produces it at a later stage according to economic criteria.

Please note:

The Power Battery is not designed for any other application or connection with other devices. Any use that differs from or goes beyond the intended usage is considered misuse. RCT Power GmbH shall not be liable for any damage resulting from misuse. Any misuse will cause the termination of the warranty, guarantee and general liability of the manufacturer.

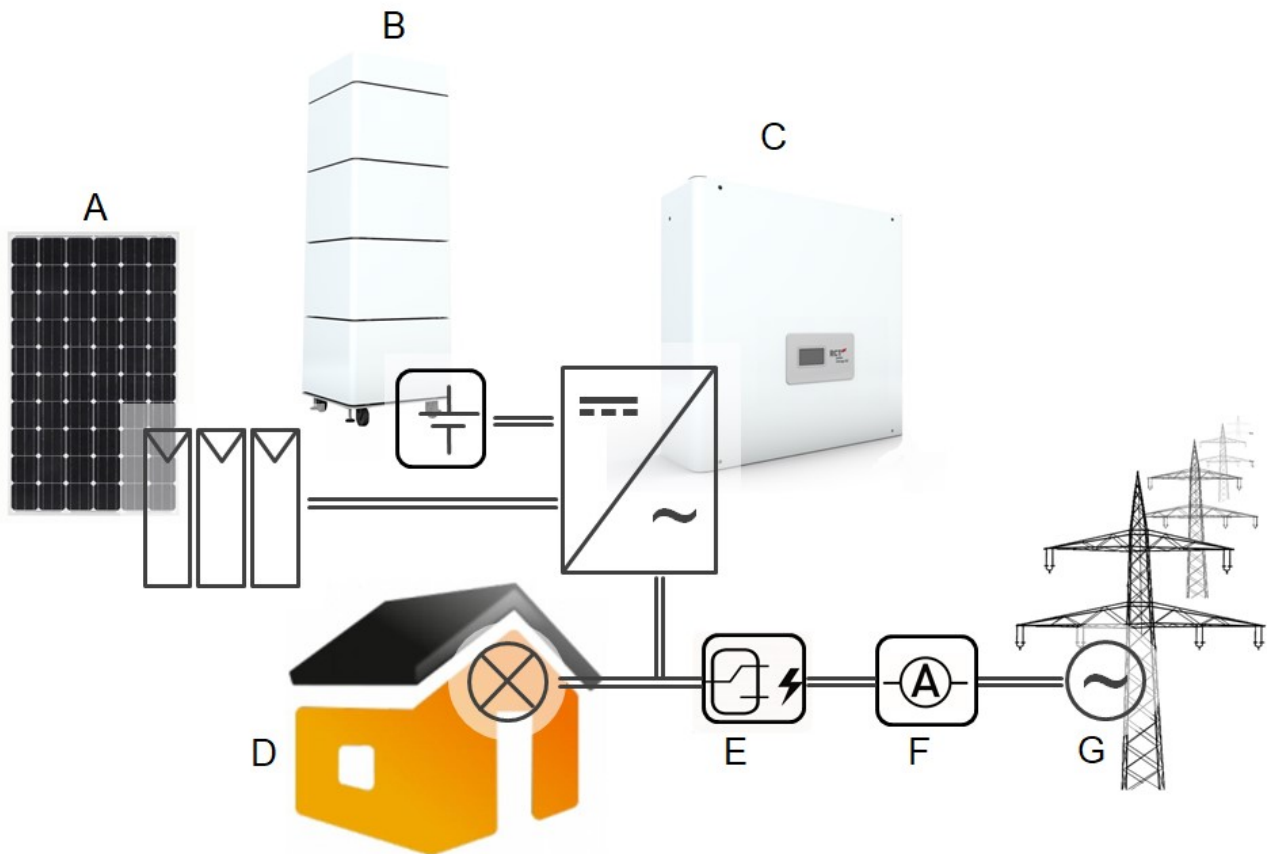

Fig. 3-1 Intended use of the Power Storage and Power Battery in the PV System

Item	Description	Note
A	PV strings	Monocrystalline silicon; polycrystalline silicon and thin-film without grounding and protection class II
B	Battery	Power Battery 3.8, 5.7, 7.6, 9.6, 11.5
C	Inverter	Power Storage 4.0, 6.0, 8.0, 10.0
D	Household Load	Household appliances
E	Power Switch	Switch Household to island mode during utility grid power outage
F	Power Sensor	Current sensors for measuring of AC power
G	Utility grid	TT, TN-C, TN-S, TN-C-S

3.2 Product description

3.2.1 Scope of delivery

Before shipment our products are checked for proper condition.

Despite careful packaging, transport damage can occur, for which the transport company is generally responsible.

If you notice any damage to the packaging or the PowerBattery, please immediately inform the transport company.

Check the content for completeness according to Fig. 3-2.

	Power Battery 3.8 – 11.5 = Power Battery Master + Power Battery Stack (2-6).
---	--

1x
Power Battery Master

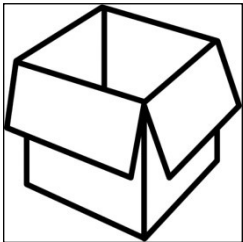

2-6x
Power Battery Stack

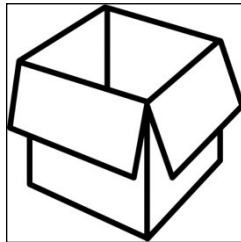

Fig. 3-2 Delivery Contents

Power Battery Master

Unpack box and check the content for completeness according to Fig. 3-2.1.

Inspect the Power Battery Master for visible damages.

Contact your supplier, if the delivery is incomplete or damaged.

Do not install, connect and operate the Power Battery Master, if any damage is detected.

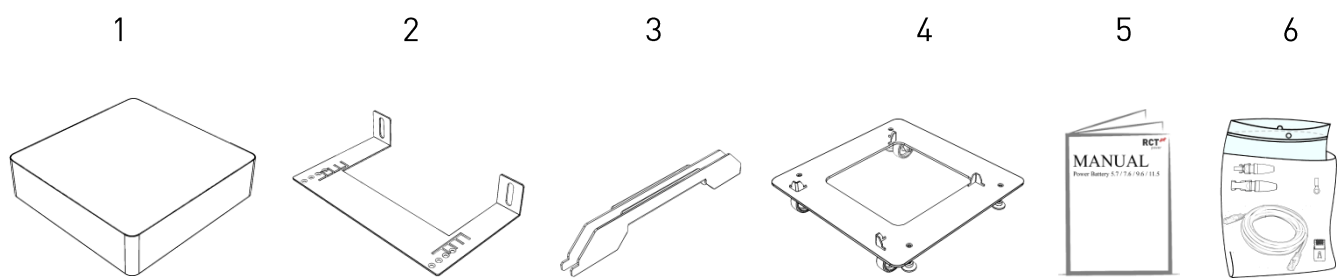
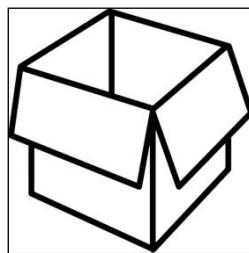

Fig. 3-3 Delivery contents of Power Battery Master

Item	Description
1	1x Power Battery Master
2	1x Wall bracket used to fix the upper part of the battery onto the wall
3	2x Handle
4	1x Floor plate (adjustable)
5	1x Manual Power Battery (this document)
6	1x Accessory packaging with: <ul style="list-style-type: none"> - 1x PV-Stick + (Weidmüller) - 1x PV-Stick - (Weidmüller) - 1x Terminating resistor (RJ 45) - 1x Patch cable RJ 45/Cat5e 5m - 1x Ring terminal (for 6mm² cable) for grounding

Power Battery Stack

Unpack box and check the content for completeness according to Fig. 3-2.2.

Inspect the Power Battery Stack for visible damages.

Contact your supplier, if the delivery is incomplete or damaged.

Do not install, connect and operate the Power Battery Stack, if any damage is detected.

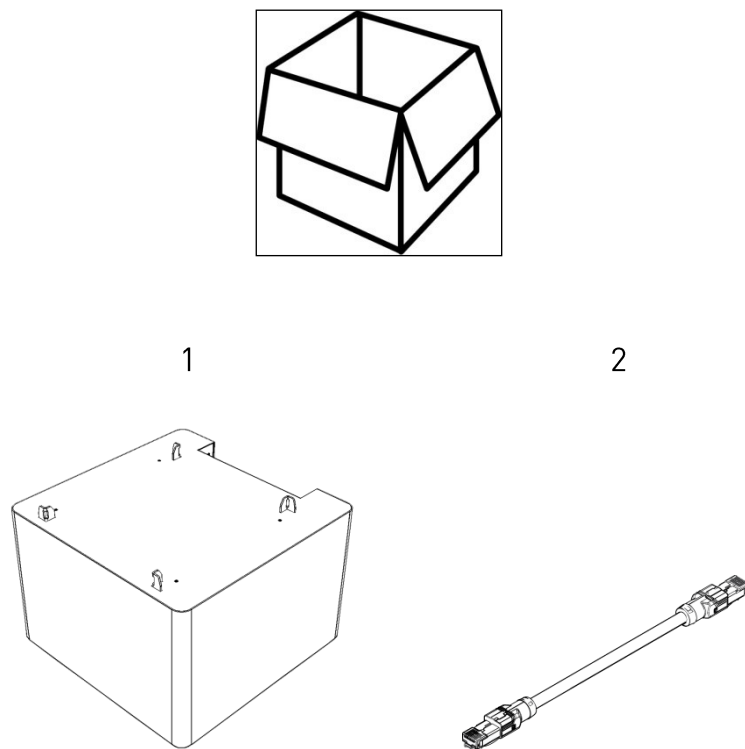
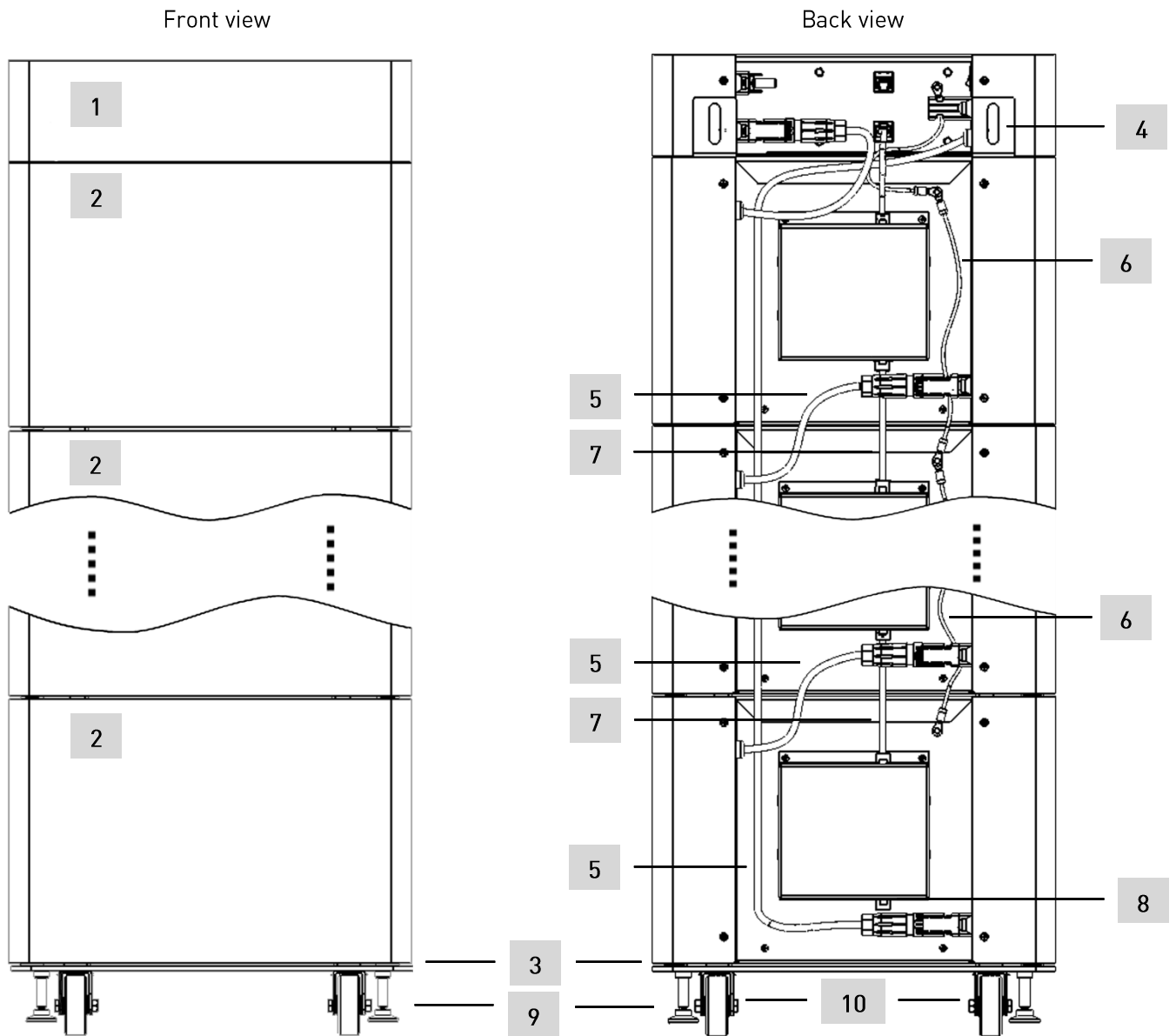

Fig. 3-4 Delivery contents of Power Battery Stack

Item	Description
1	1x Power Battery Stack
2	1x Patch cable RJ 45/Cat5e 15cm

3.2.2 Product Appearance



Item	Description
1	Power Battery Master
2	Power Battery Stack (2-6 Units)
3	Floor plate
4	Wall bracket
5	DC connection
6	Protective conductor
7	RJ45 – interface, communication
8	Terminal resistor
9	Leveling feet
10	Reels

Power Battery Master

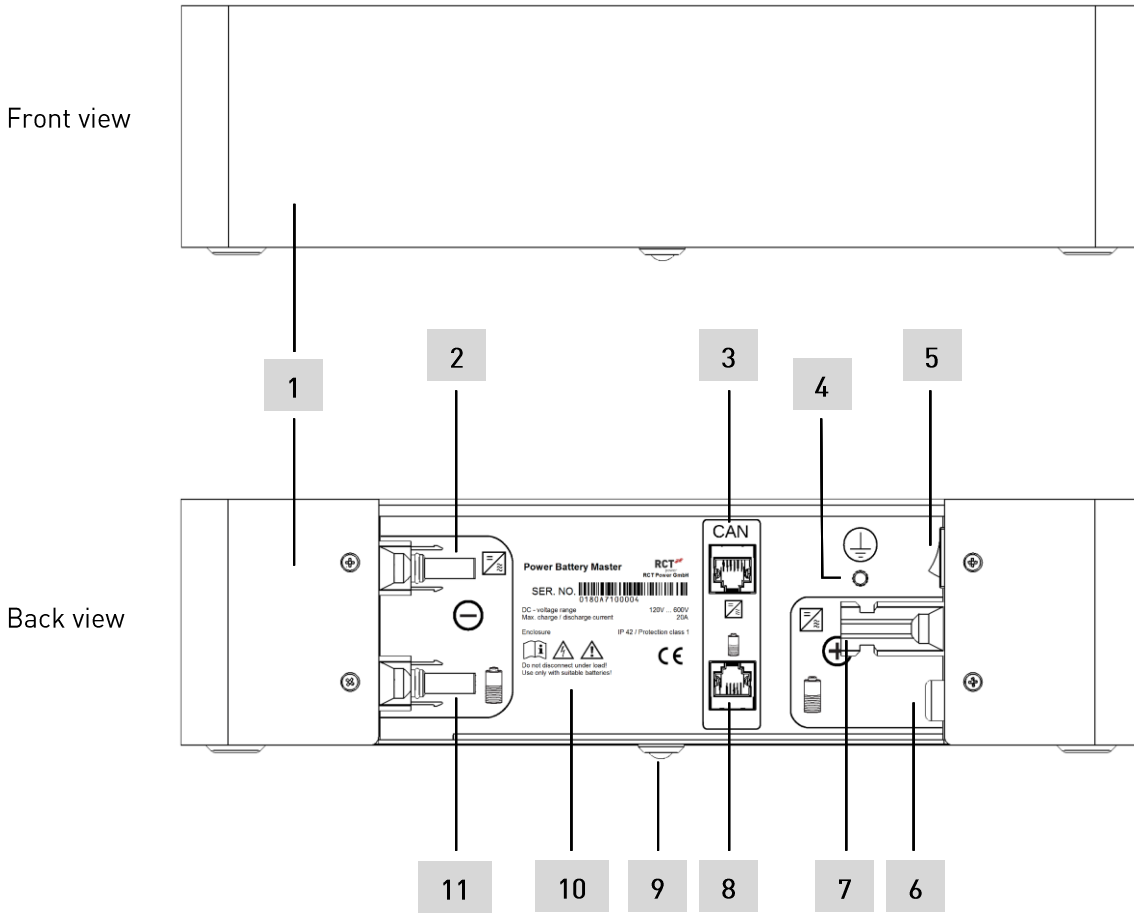

Item	Description
1	Power Battery Master
2	Output DC (-) for DC-battery connection to the Power Storage Batt (-)
3	CAN – interface, communication to the Power Storage
4	PE connection
5	On / Off switch
6	Intern DC connection (+) for the Power Battery Stack
7	Output DC (+) for DC-battery connection to the Power Storage Batt (+)
8	CAN – interface, communication to the Power Battery Stack
9	State LED
10	Name plate
11	Intern DC connection (-) for the Power Battery Stack

Power Battery Stack

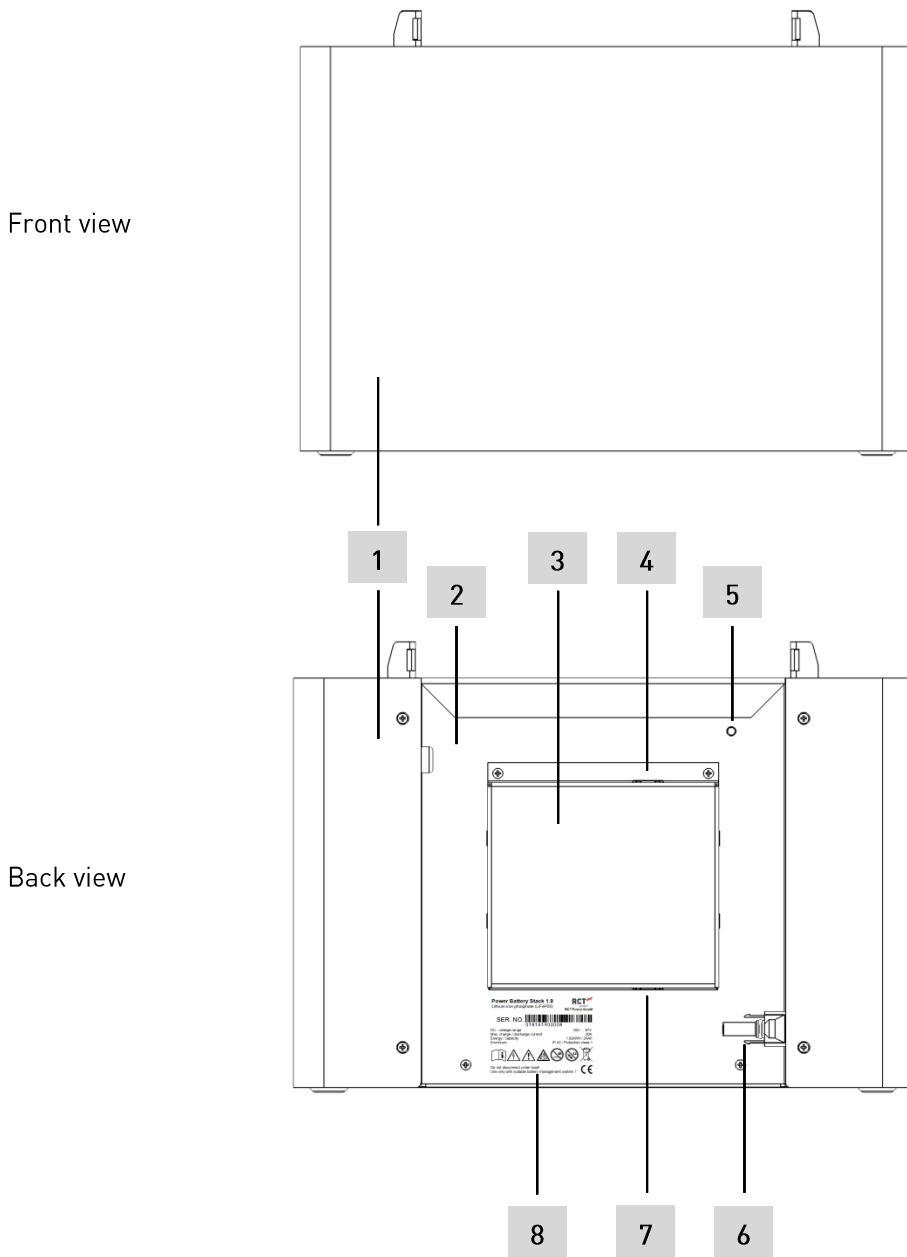

Item	Description
1	Power Battery Stack
2	DC connection (-), for the Power Battery Stack or Power Battery Master
3	Fuse cover
4	RJ45 – interface, communication to the Power Battery Stack or Power Battery Master
5	PE connection
6	DC connection (+), for the Power Battery Stack or Power Battery Master
7	RJ45 – interface, communication to the Power Battery Stack or for terminating resistor
8	Name plate

3.2.3 Name plate and warnings

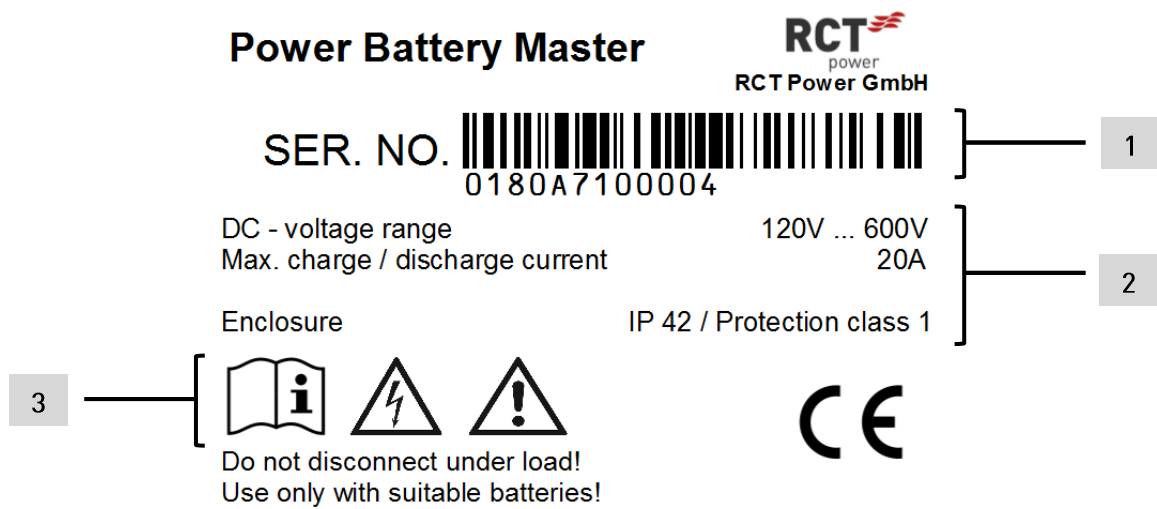

Fig. 3-5 Name plate

Item	Description
1	Serial Number
2	Technical Data
3	Symbols:



This symbol indicates that the user manual must be read and understood before putting the unit into operation.



Warning of electrical voltage.



DC voltage present in cables and inner parts of Power Battery Master.

Power Battery Stack 1.9

Lithium iron phosphate (LiFeP04)

RCT
power
RCT Power GmbH

SER. NO. 
0181A1900004

DC - voltage range 60V ... 87V
Max. charge / discharge current 20A
Energy / capacity 1,92kWh / 25Ah
Enclosure IP 42 / Protection class 1



Do not disconnect under load!
Use only with suitable battery management system !

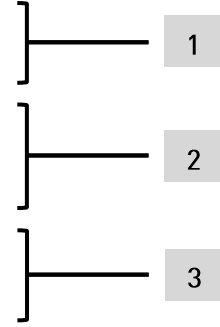

Fig. 3-6 Name plate

Item	Description
1	Serial Number
2	Technical Data
3	Symbols:



This symbol indicates that the user manual must be read and understood before putting the unit into operation.



Warning of electrical voltage.



DC voltage present in cables and inner parts of Power Battery Stack.



Danger of electrostatic dis/charging and gas explosion.



Safety indication: Not allowed battery to get wet.



Safety indication: Not allowed to operate a defect battery.



No disposal over household waste.

4 Mechanical installation

4.1 Place of installation



WARNING

Installation, service and maintenance work may only be carried out by qualified electrician.

- When moving the Power Battery the battery system can tilt.
- Use the wall bracket to secure the Power Battery.
- Do not place the Power Battery in potentially explosive atmosphere.
- There must always be 2 people available to lift and carry the batteries. The weight of the stacks is more than 18kg.

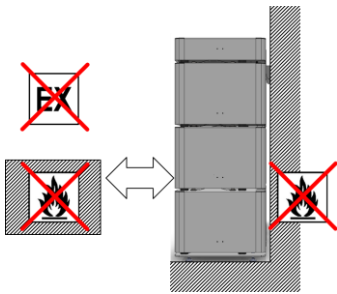

The location must be made of flame retardant material. Do not place the Power Battery in potentially explosive atmosphere. Keep away from flammable materials.

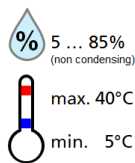

5 ... 85%
(non condensing)

max. 40°C

min. 5°C

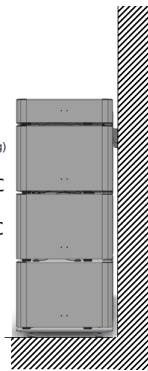

Only install the Power Battery in interior areas. Protect it from direct heat radiation (e.g. sun, heater, etc.). The following requirements must be fulfilled:

- Indoor use (conditioned).
- Ambient temperature +5 ... 40 °C.
- Relative humidity 5 ... 85 % (non condensing).

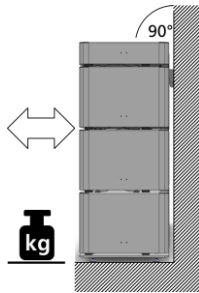

Make sure, the selected location and surface supports the weight of the battery.

The selected location must be readily and safely accessible at all times without additional aids (ladder, scaffold).

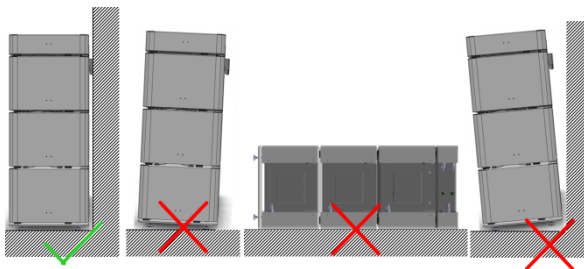

Place the battery in an upright position.

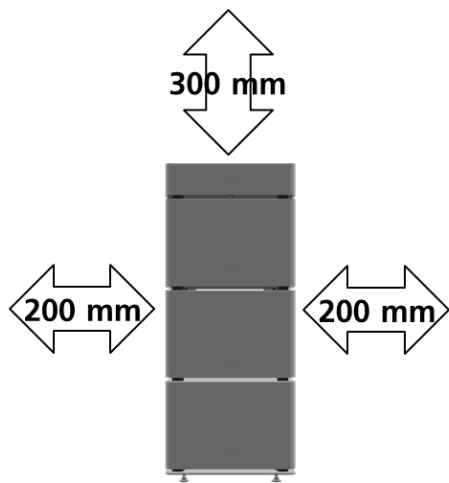

Minimum clearance to allow sufficient cooling air convection.

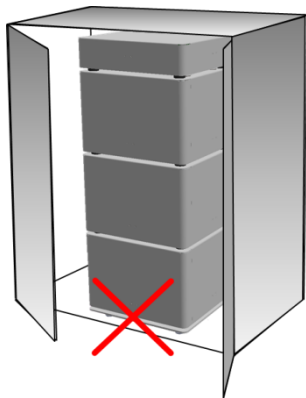

Do not place battery inside a closed cabinet.



NOTICE

- Make sure that the system has sufficient convection and is at a suitable installation location. Upon reaching a predetermined temperature threshold, the charging and discharging power of the battery is linearly reduced.

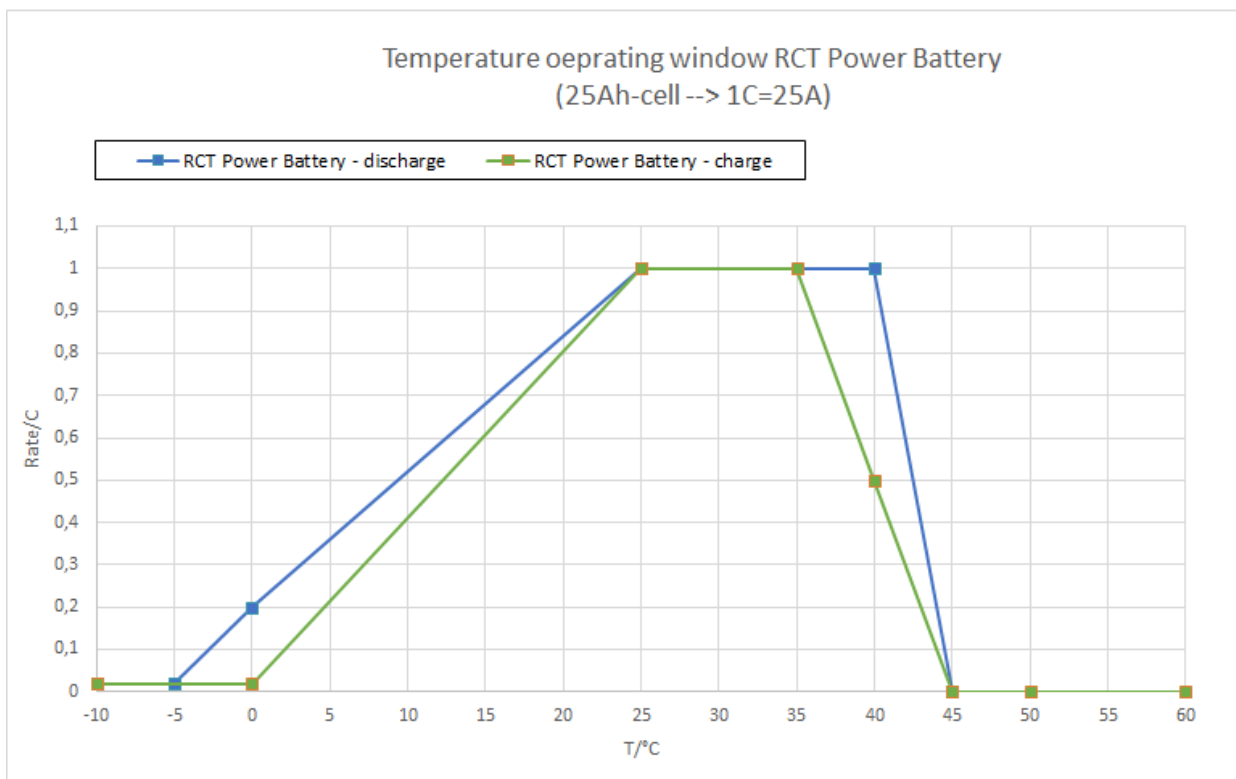

4.2 Mounting

Mounting Procedure:



First place the ground plate to the place where the Power Battery to stand later. Keep a distance of 20cm away from the wall.

The side marked by the arrow has to stand opposite the wall.

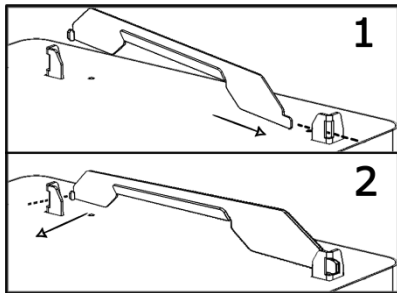

Next, place a Power Battery Stack with the included mounting handle on the ground plate, so that the connections look towards the wall.

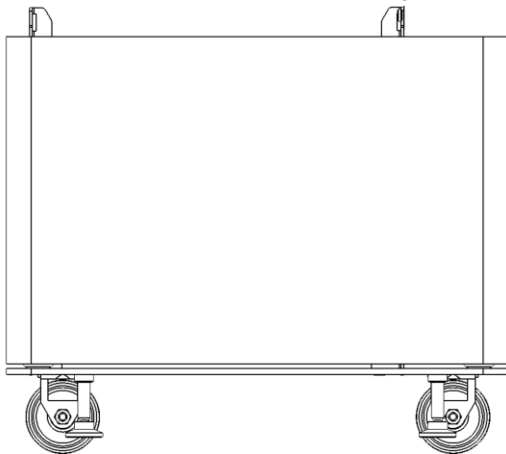
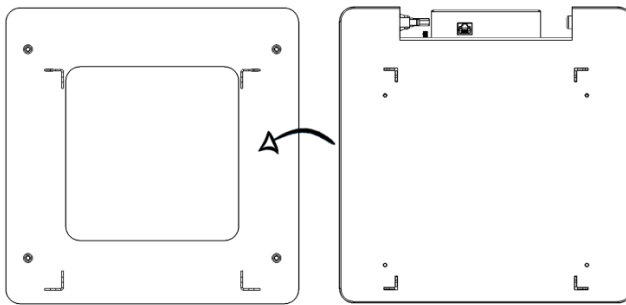

Make sure that no cables are pinched during assembly and that the parts of the Power Battery are parallel to the ground.

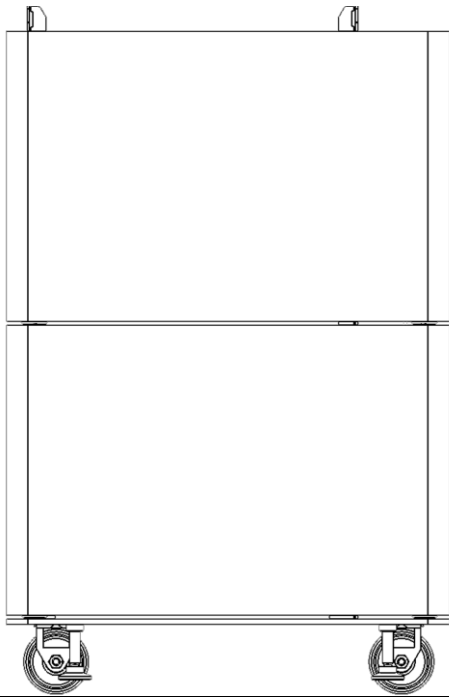

Put another Power Battery Stack on the first one, so that they match with each other.

Repeat this until all Power Battery Stacks are set up.

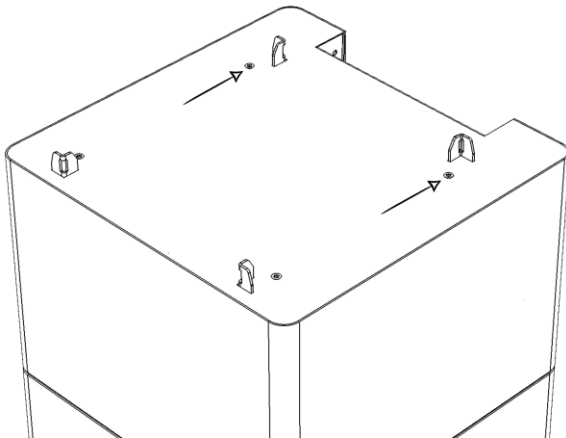

To attach the wall bracket, remove the two screws on the top stack (preferred Torx T20).

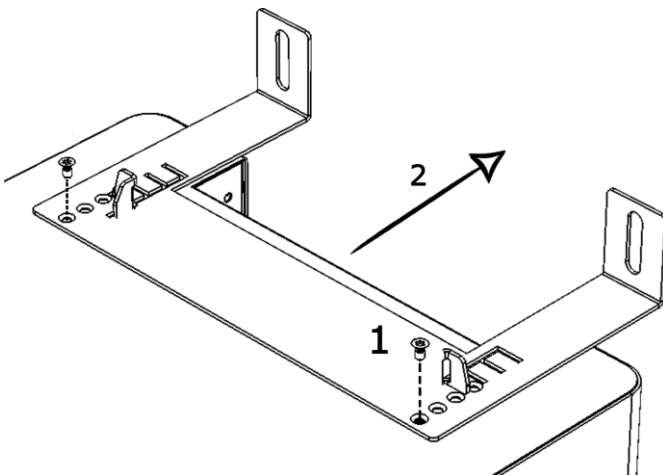

First take the wall bracket and attach it to the top Power Battery Stack.

After the wall bracket is attached, slide careful the battery to the wall to take markings for the bore holes.

At last put the Power Battery Master on the top of the Power Battery Stack.

5 Electrical connection

5.1 Wiring Power Battery

In the following sections is described the wiring of the Power Battery:

- 5.1.1 Protective earth
- 5.1.2 Communication
- 5.1.3 DC wiring

Before starting wiring, make sure that the Power Battery Master On / Off switch is set to off (Position "0".)

After the Power Battery has been built up, the cabling on the back of the housing can be started.

Pull away the battery from the wall to get enough space for wiring.

5.1.1 Protective earth connection

The Power Battery must be connected to a protective conductor. For this purpose, a line from the potential equalization rail to the housing of the lowest stack must be installed expertly.

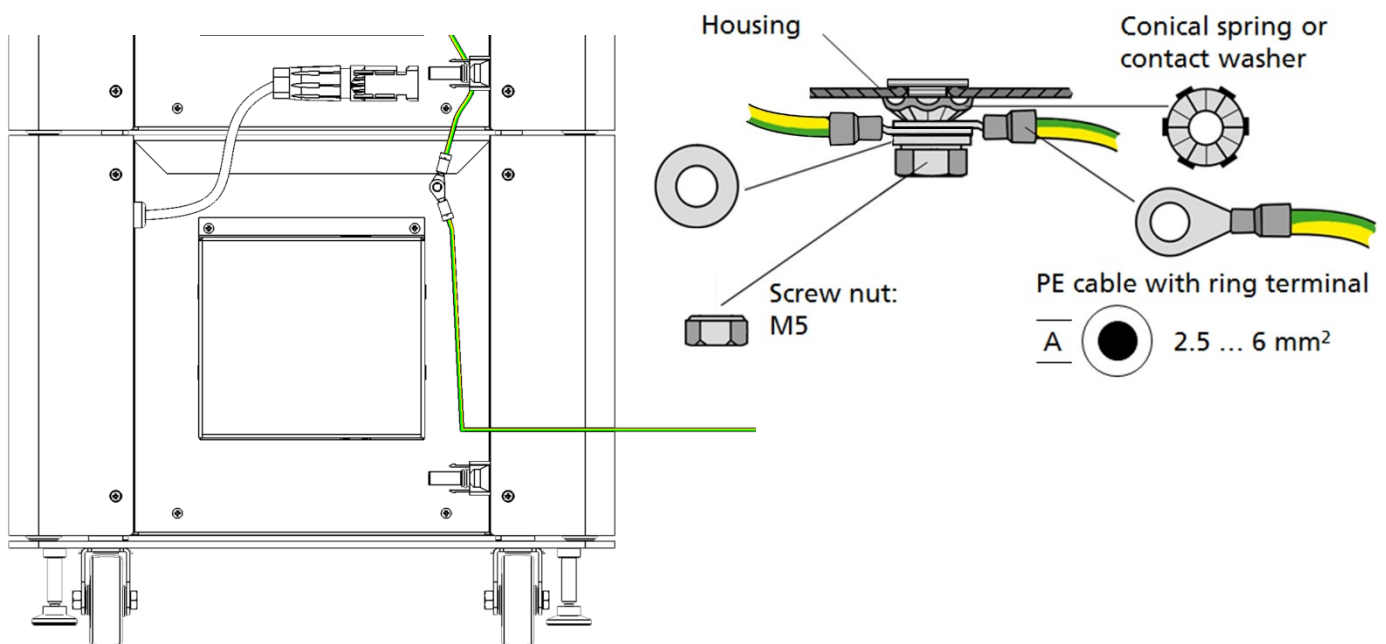
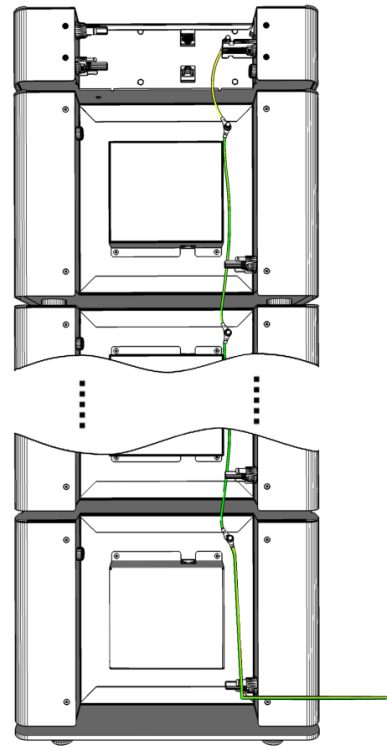

Fig. 5-5 Connection parts and assembly for protective earth connection of inverter housing

Connect all other modules with a protective conductor in series from the lower protective earth connection on the housing.



5.1.2 Communication connection

For the communication between the individual modules use the enclosed patch cables and terminating resistor.

Please connect the top Stack to the lower RJ-45 connector on the Battery Master.

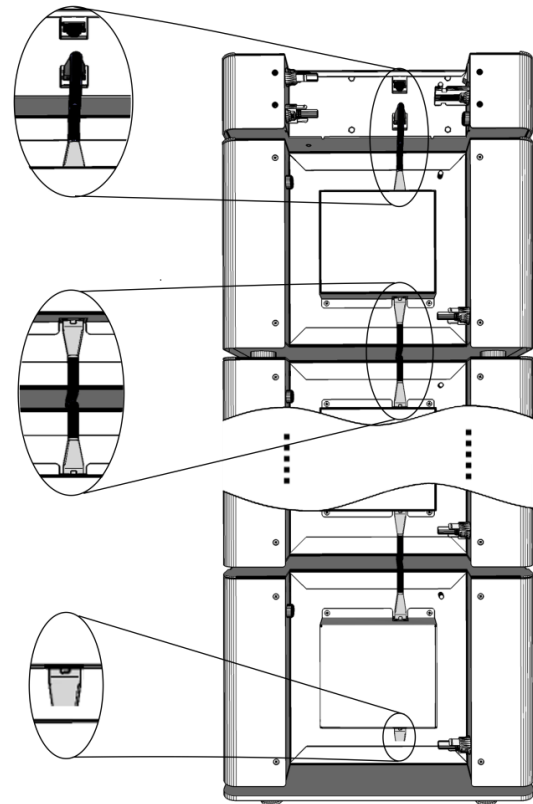

Now connect all other modules with the patch cable.

Connect the attached terminating resistor to the bottom of the lowest module.

5.1.3 DC connection

All Power Battery Stacks are connected in series. Therefore Power Battery Master has to be connected to the first and the last Power Battery Stack. The Power Battery Stacks in between has to be connected to the next one.

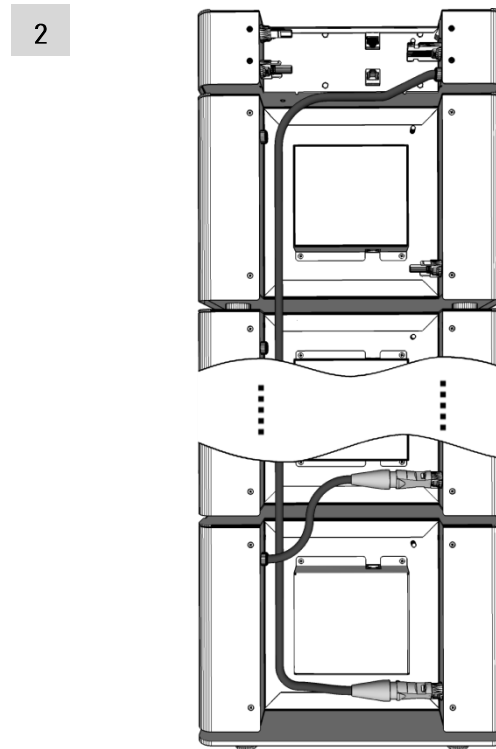
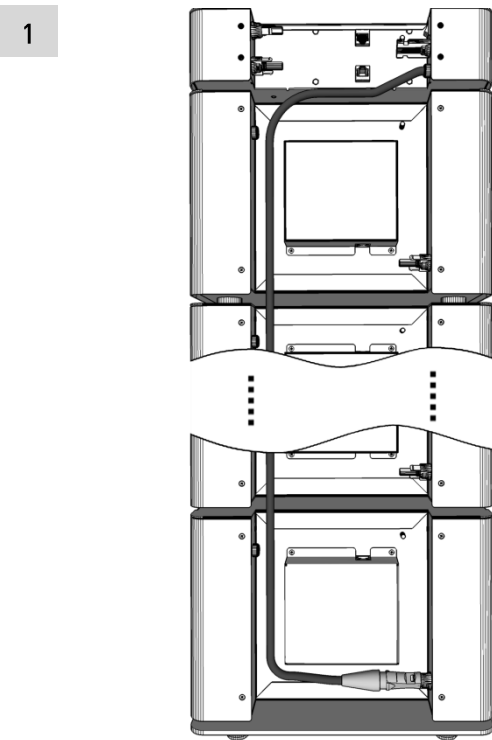

Connect the positive DC cable from the Power Battery Master in the positive connector of the lowest Power Battery Stack. It is advisable to route the dc cable between the case and the dc cable from the stack.

Plug the negative DC cable from the lowest Power Battery Stack to the positive connector of the Stack above.

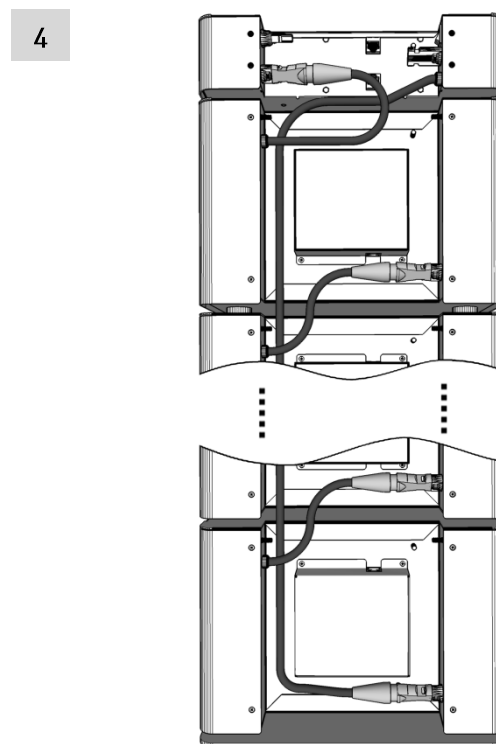
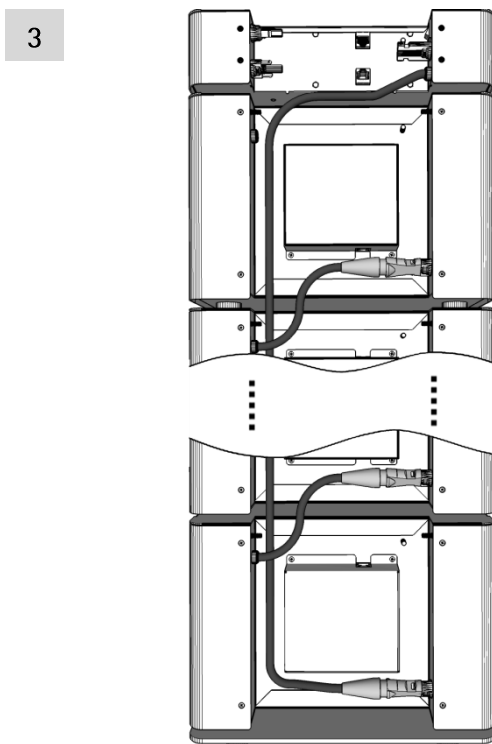

Repeat this until reached the last Power Battery Stacks.

Plug the negative DC cable from the top Power Battery Stack in the negative connector of the Power Battery Master.

5.2 Battery connection to the inverter



DANGER

Risk of death or serious injury due to electric shock!

- Touching voltage conductors parts can result in death!
- Prepare all battery cables before connecting the Power Battery to the Power Storage.
- Cables may only be connected or disconnected in a voltage-free state.
- Cable routing: prevent tensile force on cables and connectors, avoid sharp edges and observe maximum bending radius.



NOTICE

- Check cables for correct polarity.
- Make sure DC switch is turned to "0" position before plugging in connectors.
- Make sure that the Power Battery Master is suitable for min- and maximum system voltage and system voltage does not exceed maximum input of inverter.



- Any kind of soiling (dust, moisture, etc.) has a negative effect on the connector system with regard to function over the intended period of use. Therefore, extreme care must be taken to achieve proper processing during assembly.

5.2.1 Assembly of DC connection conductor

Preparing:

Weidmüller PV-Sticks



2x (enclosed with Power Battery Master)
2x (enclosed with Power Storage)

PV cable



4-6mm², not included

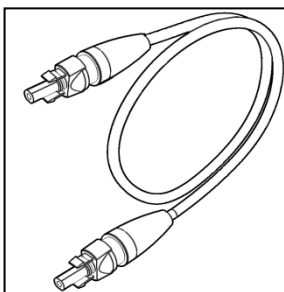

DC cable +

Make sure that the same type of plug is used when assembling the DC cable + on both sides.

Plug type:

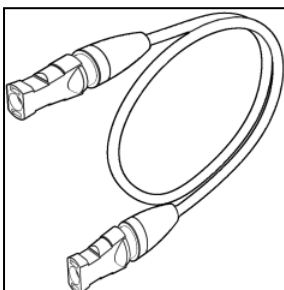

DC cable -

Make sure that the same type of plug is used when assembling the DC cable - on both sides.

Plug type:



Preparing the cable:



Only for use with
PV cable

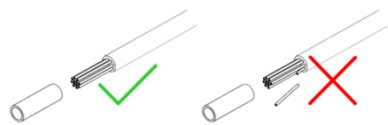

Strip the cable carefully.

Take care not to damage individual strands of the cable.

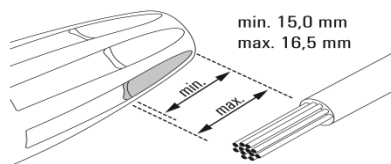

Check the length of the exposed wires at the connector.

Min. 15mm

Max. 16,5mm



Twist the conductor.

Inserting the cable:

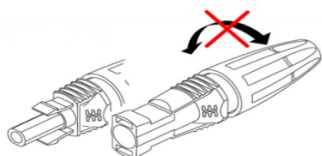

Do not twist before wiring.

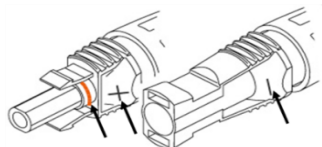

Chose the correct connector type.

Pay attention to the polarity.

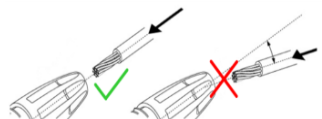

Insert the cable straight into the connector.

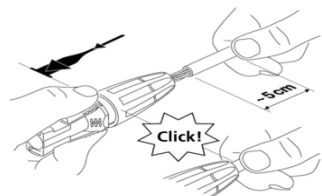

Make sure that the contact locks with a "click".

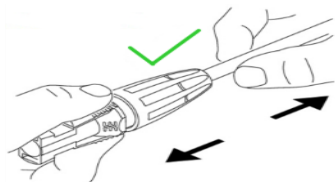

Check the correct locking by a slight pull on the cable.

Connecting the cable:

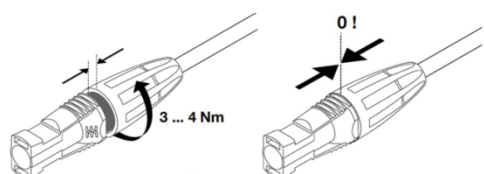

Turn the plug on.

5.2.2 Preparation for wiring to the inverter



DANGER

Risk of death or serious injury due to electric shock!

- Only by RCT Power GmbH specified and certificated battery systems are allowed to be connected here! Check cables for correct polarity.
- Cables may only be connected or disconnected in a voltage-free state.



NOTICE

- Check cables for correct polarity.
- Make sure DC switch on the Power Battery is set to "0" position before plugging in connectors.

Install the electrical connection to the Power Battery Master but do not plug it to the inverter yet, before it is mechanically fixed!

1

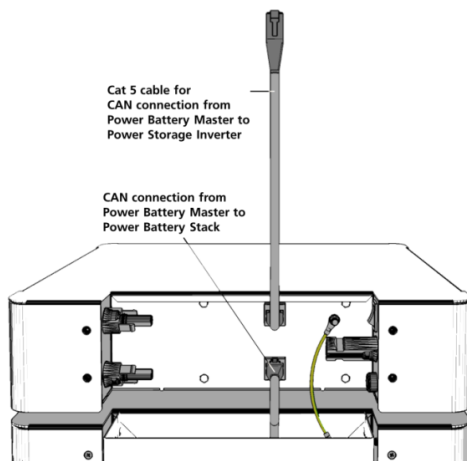

Plug the communication link into the Power Battery Master

2

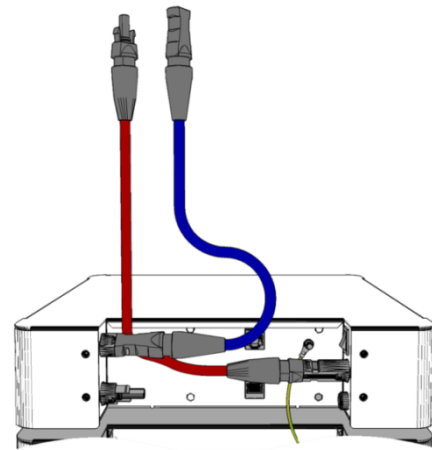

Connect the DC cable into the Power Battery Master.

5.2.3 Fix the Power Battery on the wall

Additionally required material (not included in delivery):

- Two screws with diameter max of 8 mm
- 14er fork key
- Matching washers with minimum outer diameter of 15 mm

Move the Power Battery carefully to the wall and fix it to the wall by using two screws over the wall bracket.

To prevent accidental tipping over, you should attach the Power Battery to the wall.

Then unscrew the leveling feet from the bottom plate and align.

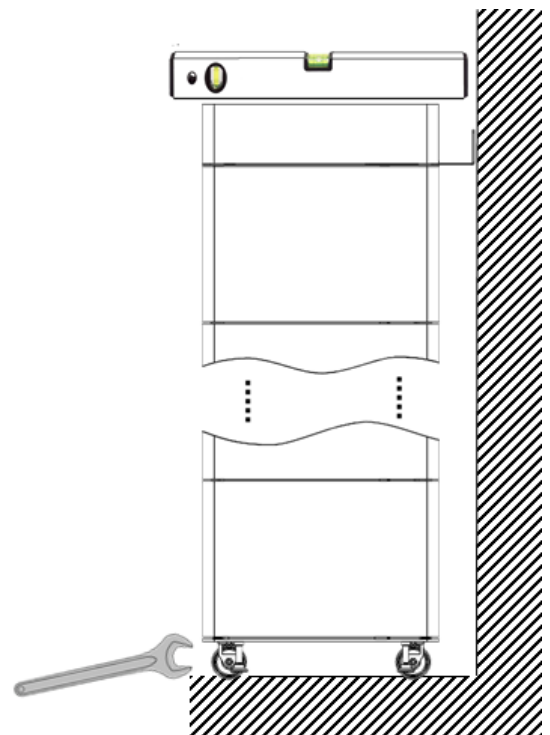

5.2.4 Connection to Power Storage DC 4.0 / 6.0

Remove the cover of the inverter to plug the connection.

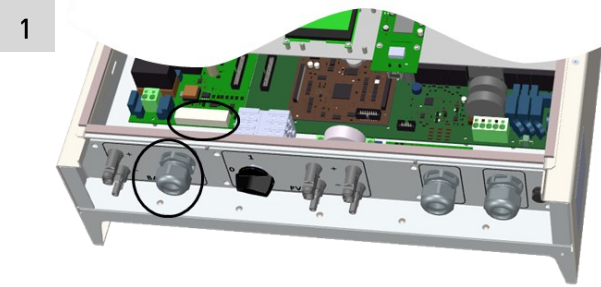

Feed the cat 5 cable from Power Battery Master through the cable entry and insert cable in RJ45 connectors X403 "CAN".

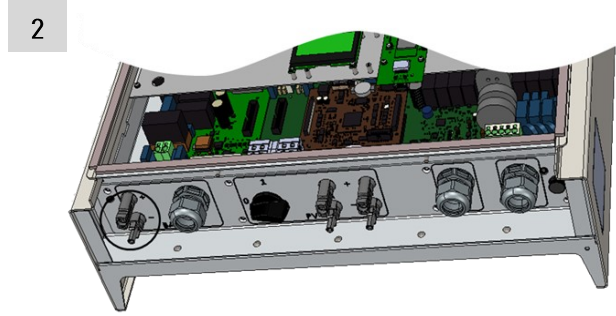

Connect the DC cable into the Power Battery Master.

5.2.5 Connection to Power Storage DC 8.0 / 10.0

Remove the cover of the inverter to plug the connection.

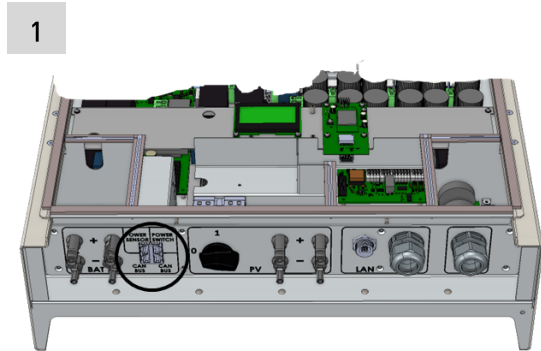

Plug the cable into the RJ45 connector (CAN).

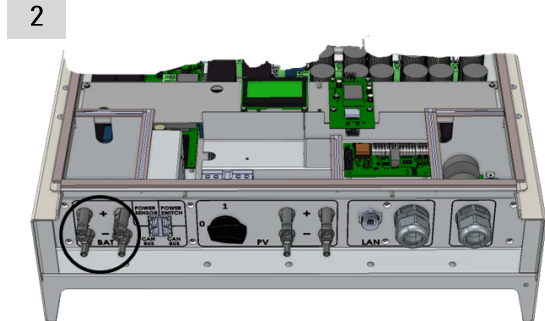

Batterie DC-Input of Power Storage DC 8.0/10.0.

5.2.6 Connection to Power Storage AC

Remove the cover of the inverter to plug the connection.

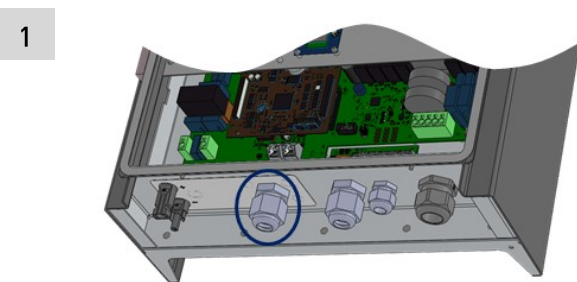

Feed the cat 5 cable from Power Battery Master through the cable entry and insert cable in RJ45 connectors CAN BUS "A".

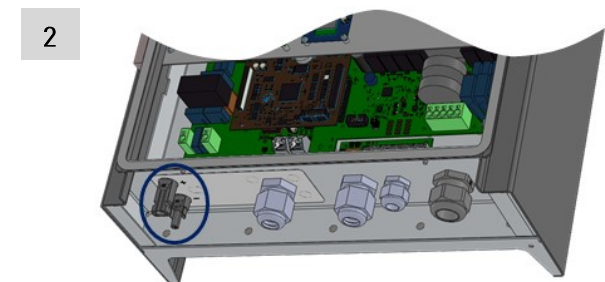

Connect the DC cable into the Power Battery Master.

6 Commissioning

Commissioning the system, please follow the procedure in the Setup Power Storage.

7 Maintenance

7.1 Maintenance

The Power Battery contains not any parts to be serviced.

In case of faults, please contact the service of RCT Power GmbH.

7.2 Incident announcement

The Power Battery has a status signal.

About the permanently integrated LED in the housing, displayed are the following states:

LED state	Description
Green	Operable/workable (battery is connected).
Red	Disruption (battery is not connected).
Orange	Initialization (battery is not connected).
Red/Orange (blinking)	CAN connection to the inverter is interrupted.
Red/green (blinking)	Update (battery is not connected).

If faults, warning or events of the Power Battery occur, these are reported on the display of the inverter or can be called up via the RCT Power App.

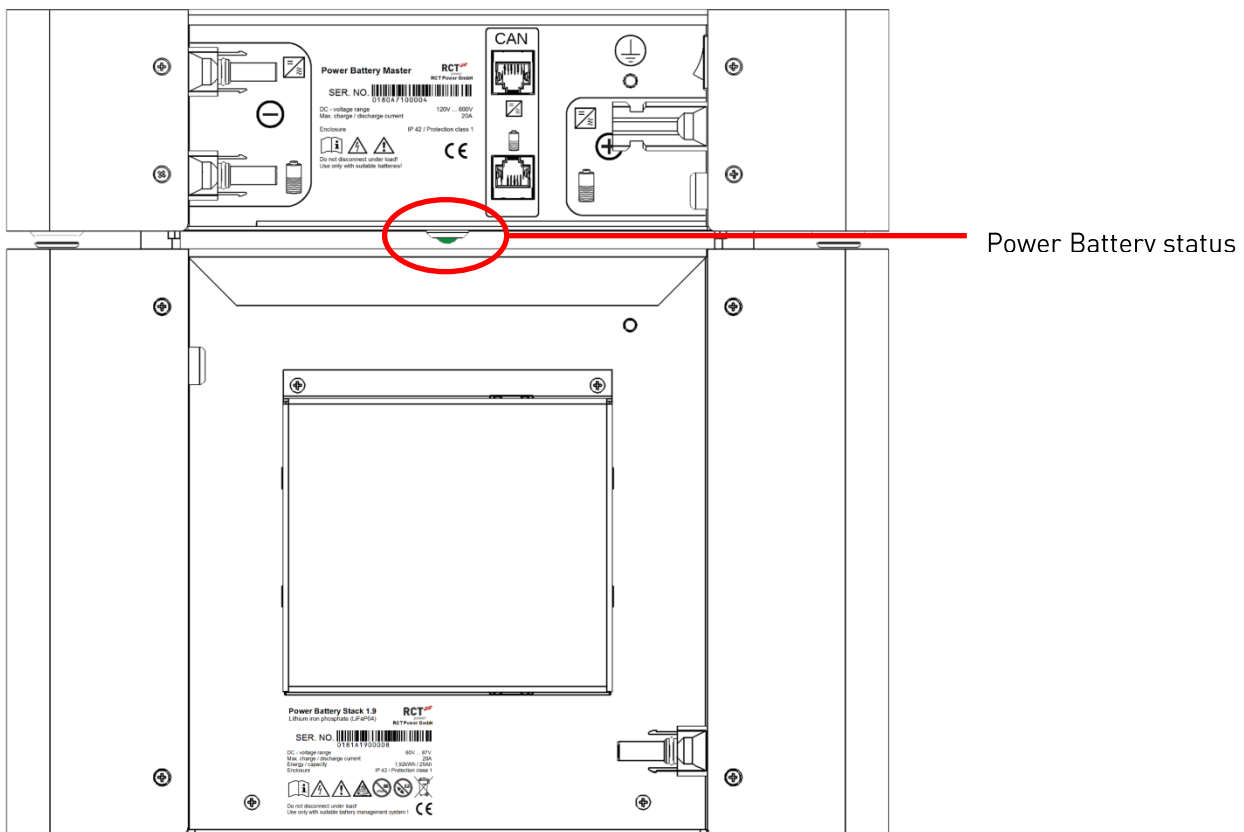

8 Storage, cleaning and disposal

8.1 Storage

Store the Power Battery Stacks in a clean, dry, cool, frost-free room, non-flammable and non-conductive material. Too high storage temperature results in faster self-discharge and premature aging.

To avoid damage, store the Power Battery Stack in an environment with relative humidity <85%, no corrosive gas and a storage temperature from -30°C to 40°C.

For long-term storage of longer than 3 months, store the Power Battery Stack in a relative humidity environment <65%, no corrosive gas and a storage temperature from -10°C to 25°C.

8.2 Cleaning

Use a dry cotton cloth to clean the case from the outside.

It is strictly forbidden to clean with synthetic cloths or a feather duster. Otherwise there is the risk of electrostatic charging or discharging.

8.3 Disposal

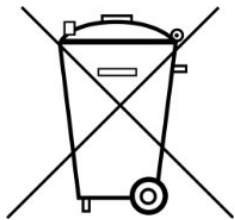

According to the marking with the crossed-out waste bin, the Power Battery and parts of it must not be added to the household waste. You will find precious metals, which are recycled and reclaimed for new exploited.

Observe local regulations for disposal.

If you have questions about the disposal, please contact the service first.

9 Exclusion of liability

Although information contained in this manual has been checked with the greatest care for its accuracy and completeness, not liability whatsoever can be accepted for errors or omissions.

RCT Power GmbH reserves the right to change the hardware and software features described here at any time without prior notice.

Guarantee or liability claims for damages of any kind are excluded, if they are caused by one or more of the followings:

- Inappropriate use or installation of the product
- Installing or operating the product in an unintended environment
- Ignoring relevant safety regulations in the deployment location when installing or operating the product
- Ignoring safety warnings and instructions contained in all documents relevant to the product
- Installing or operating the product under incorrect safety or protection conditions
- Altering the product or supplied software without authority
- The product malfunctions due to operating attached or neighboring devices beyond allowed limit values
- Damages caused by natural environment

This manual may not be reproduced, passed on, copied or translated into other languages in whole or in part in any form or with any means without prior written approval by RCT Power GmbH.

RCT Power GmbH shall assume no guarantee for damage caused by faulty or lost data, due to incorrect operation or the malfunction of the inverter, the software, additional devices or PCs.

10 Appendix

Installer

Company:

Name:

Address:

E-Mail:

Phone:

Power Battery

Power Battery	Serial number	Date of install
Power Battery Master		
Power Battery Stack 1.9		
Power Battery Stack 1.9		
Power Battery Stack 1.9		
Power Battery Stack 1.9		
Power Battery Stack 1.9		
Power Battery Stack 1.9		

11 Technical Data

Power Battery	3.8	5.7	7.6	9.6	11.5
---------------	-----	-----	-----	-----	------

ELECTRICAL PARAMETERS

Nominal capacity	3,84kWh	5,76kWh	7,68kWh	9,60kWh	11,52kWh
Usable capacity	3,46kWh	5,18kWh	6,91kWh	8,64kWh	10,37kWh
Cycle Life (at 80% remaining capacity)	5000				
Voltage range	120 V ... 173 V	180 V ... 260 V	240 V ... 346 V	300 V ... 432 V	360 V ... 520 V
Nominal voltage	154 V	230 V	307 V	384 V	461 V
Maximum charge/ discharge current	25A/25A	25A/25A	25A/25A	25A/25A	25A/25A
Standby consumption	< 5 W				

INTERFACE

Power storage interface	CAN
-------------------------	-----

GENERAL

Battery technology	LiFeP04				
Dimensions (height x width x depth)	0,62x0,34x0,34m	0,87x0,34x0,34m	1,12x0,34x0,34m	1,36x0,34x0,34m	1,61x0,34x0,34m
Weight (single module 24 kg)	54 kg	78 kg	102 kg	126 kg	150kg
Number of battery units	2	3	4	5	6
IP degree of protection	IP42				
Type of installation	floor stand / indoor				
Operating temperature range	+5°C ... +40°C				
Connector type	Weidmüller PV-Stick (MC4 compatible)				

SAFETY / STANDARDS

Protection class	1
Declaration of conformity	CE, UN 38-3, IEC 62133, IEC 62619, Safety guidelines BVES for battery storage systems
EMC	EN61000-6-2, EN55022
Safety	EN/IEC 61010-1

BLOCK DIAGRAM

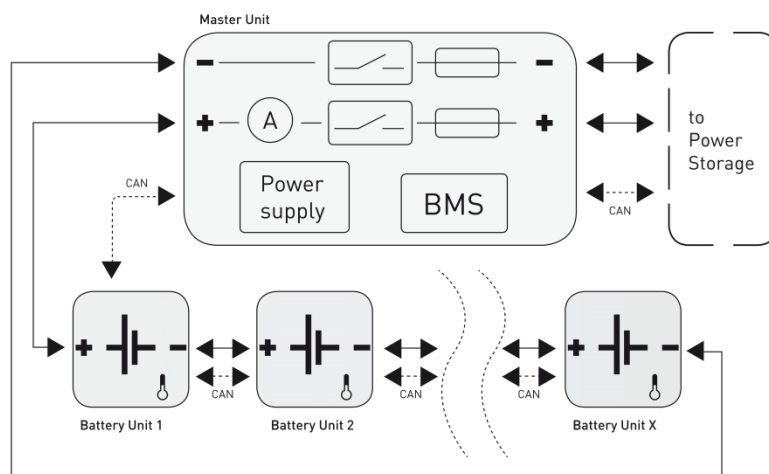

RCT Power GmbH

Line Eid Str. 1

78467 Konstanz, Deutschland

Tel.: +49 (0)7531 996 77-0

Mail: info[at]rct-power.com

Internet: www.rct-power.com